



Operating Instructions
thicknessSENSOR

10/200
10/400

25/200
25/400

Sensor for thickness measurement

MICRO-EPSILON
MESSTECHNIK
GmbH & Co. KG
Königbacher Strasse 15

94496 Ortenburg / Germany

Phone +49 (0) 8542 / 168-0
Fax +49 (0) 8542 / 168-90
email info@micro-epsilon.com
www.micro-epsilon.com

Contents

1.	Safety	5
1.1	Symbols Used	5
1.2	Warnings	5
1.3	Notes on CE Marking	5
1.4	Notes on UKCA Marking.....	6
1.5	Intended Use	6
1.6	Foreseeable Misuse.....	6
1.7	Proper Environment.....	6
2.	Laser Safety	7
3.	Functional Principle	8
3.1	Base Frame.....	8
3.2	Sensors	9
3.3	Calibration Target.....	9
3.4	Technical Data	10
4.	Delivery	11
4.1	Unpacking /Included in Delivery	11
4.2	Storage	11
5.	Mounting	12
5.1	General	12
5.2	Error Influences	12
5.2.1	Ambient Light	12
5.2.2	Color Differences	12
5.2.3	Surface Roughness	12
5.2.4	Temperature Influences	12
5.2.5	Movement Blurs	12
5.2.6	Optimizing the Measuring Accuracy	13
5.3	Mechanical Fastening, Dimensional Drawing	14
5.4	Control and Display Elements.....	18
5.5	Electrical Connections.....	18
5.5.1	Connection Possibilities	18
5.5.2	Pin Assignment.....	19
5.5.3	Power Supply	19
5.5.4	Current Output.....	19
5.5.5	Voltage Output.....	20
5.5.6	Trigger, Master Function Inputs.....	20
5.5.7	Switching Outputs.....	20
5.5.8	Connector and Sensor Cable.....	21
6.	Operation	22
6.1	Getting Ready for Operation	22
6.2	Operation Using Ethernet.....	22
6.2.1	Requirements	22
6.2.2	Access via Ethernet.....	23
6.2.3	Measured Value Display with Web Browser	25
6.3	Home Menu	26
6.4	Preferences Menu.....	27
6.4.1	Language Selection.....	27
6.4.2	Sensors.....	27
6.4.3	Measuring Rate	28
6.4.4	Filter / Averaging / Error Handling Inside thicknessSENSOR	29
6.4.5	Zeroing / Mastering	31
6.4.6	Digital Interfaces	32
6.4.6.1	Selection of Digital Interfaces	32
6.4.6.2	Data Selection	33
6.4.6.3	Ethernet Settings.....	34
6.4.7	Analog Outputs.....	35
6.4.7.1	Analog Output 1 and 2.....	35
6.4.8	Digital Ports	37
6.4.8.1	Digital Input	37
6.4.8.2	Digital Outputs.....	37
6.4.9	Output Data Rate	38
6.4.10	Trigger Mode	39
6.4.11	Load/Save Settings	40
6.4.12	Manage Settings on PC	41
6.4.13	Extras.....	43
6.4.13.1	Language	43
6.4.13.2	Factory Defaults	43
6.4.13.3	Reset of Controller	44
6.5	Measuring Menu	45
6.6	Help/Info Menu	47
7.	Software Support with MEDAQLib	48
8.	Disclaimer	48
9.	Service, Repair	49
10.	Decommissioning, Disposal	49

Appendix

A 1	Accessories	50
A 2	Factory Defaults	51
A 2.1	Home	51
A 2.2	Sensors	51
A 2.3	Measuring Rate	51
A 2.4	Filter / Averaging / Error Handling inside thicknessSENSOR	51
A 2.5	Zeroing/Mastering	51
A 2.6	Digital interfaces	51
A 2.7	Analog Outputs	51
A 2.8	Digital Ports	52
A 2.9	Output Data Rate	52
A 2.10	Trigger Mode	52
A 2.11	Load/Save Settings	52
A 2.12	Extras	52
A 3	Pin Assignment	53
A 4	ASCII Communication with the Sensor	54
A 4.1	General	54
A 4.2	Data Protocol	54
A 4.3	Commands Overview	57
A 4.4	Commands	58
A 4.4.1	Controller Information	58
A 4.4.2	Search Sensor	58
A 4.4.3	Sensor Information	58
A 4.4.4	Read all Settings	58
A 4.4.5	Language Setting	58
A 4.4.6	Synchronization	59
A 4.4.7	Boot the Controller	59
A 4.4.8	Triggering	59
A 4.4.8.1	Trigger Selection	
A 4.4.8.2	Trigger Level	
A 4.4.8.3	Number of Measured Values to be Output	
A 4.4.8.4	Software Trigger Pulse	
A 4.4.9	Ethernet	60
A 4.4.10	Setting the Measured Value Server	60
A 4.4.11	Transmission Rate	60
A 4.4.12	Save Parameters	60
A 4.4.13	Load Parameters	60
A 4.4.14	Factory defaults	60
A 4.4.15	Measurement Mode	61
A 4.4.16	Measuring Rate	61
A 4.4.17	Measured Value Averaging Controller	61
A 4.4.18	Measured Value Averaging Sensor	61
A 4.4.19	Mastering / Zeroing	61
A 4.4.20	Selection Digital Output	61
A 4.4.21	Output Data Rate	62
A 4.4.22	Scale Output Values	62
A 4.4.23	Error Handling	62
A 4.4.24	Data Selection for USB	62
A 4.4.25	Data Selection for Ethernet	63
A 4.4.26	Function Selection Multi-function Input	63
A 4.4.27	Activate Error Output, Switching Output 1	63
A 4.4.28	Activate Error Output, Switching Output 2	63
A 4.4.29	Limit Values	64
A 4.4.30	Data Selection	64
A 4.4.31	Output Area	64
A 4.4.32	Two-point Scaling	64
A 4.4.33	Send Command to Connected Sensor	65
A 4.4.34	Laser off / Laser on	65
A 4.4.35	Find thicknessSENSOR	65
A 4.5	Error Values via USB	65
A 4.6	Error Values via Ethernet	65

1. Safety

System operation assumes knowledge of the operating instructions.

1.1 Symbols Used

The following symbols are used in this instruction manual.



Indicates a hazardous situation which results in minor or moderate injuries if not avoided.



Indicates a situation that may result in property damage if not avoided.



Indicates a user action.



Indicates a tip for users.

Measure

Indicates hardware or a software button/menu.

1.2 Warnings

Avoid unnecessary laser radiation to be exposed to the human body.

 Switch off the sensor for cleaning and maintenance.

 Switch off the sensor for system maintenance and repair if the sensor is integrated into a system.

Caution - use of controls or adjustments or performance of procedures other than those specified may cause harm.



Connect the power supply and the display / output device in accordance with the safety regulations for electrical equipment.

> Risk of injury

> Damage to or destruction of the sensors, the controller

The power supply must not exceed the specified limits.

> Risk of injury

> Damage to or destruction of the sensors, the controller



Avoid shocks and impacts to the sensors, the mechanics.

> Damage to or destruction of the sensors, the controller

Do not clean the protective glass of the sensors with water.

> Damage to the protective glass

1.3 Notes on CE Marking

The following apply to the thicknessSENSOR:

- EU Directive 2014/30/EU,
- EU Directive 2011/65/EU

Products which carry the CE mark satisfy the requirements of the EU directives cited and the relevant applicable harmonized European standards (EN). The sensor is designed for use in industrial environments.

The EU Declaration of Conformity and the technical documentation are available to the responsible authorities according to the EU Directives.

1.4 Notes on UKCA Marking

The following apply to the thicknessSENSOR:

- SI 2016 No. 1091:2016-11-16 The Electromagnetic Compatibility Regulations 2016
- SI 2012 No. 3032:2012-12-07 The Restriction of the Use of Certain Hazardous Substances in Electrical and Electronic Equipment Regulations 2012

Products which carry the UKCA mark satisfy the requirements of the directives cited and the relevant applicable standards. The sensor is designed for use in industrial environments.

The UKCA Declaration of Conformity and the technical documentation are available to the responsible authorities according to the UKCA Directives.

1.5 Intended Use

- The thicknessSENSOR is designed for use in industrial and laboratory applications. It is used for
 - thickness measurement
 - quality monitoring and dimensional inspection
 - profile measurement
- The sensor must only be operated within the limits specified in the technical data, see [Chap. 3.4](#).
- The sensor must be used in such a way that no persons are endangered or machines and other material goods are damaged in the event of malfunction or total failure of the controller.
- Take additional precautions for safety and damage prevention in case of safety-related applications.

1.6 Foreseeable Misuse

If the target/strip material flow has started, the calibration component holder may not be retracted. Collision of the target/strip material with the calibration component holder.

During the reference measurement, the target/strip material flow may not be started. Collision of the target/strip material with the calibration component holder.

1.7 Proper Environment

- Protection class: IP 65
- Operating temperature: 0 ... 50 °C (+32 ... +122 °F) (non-condensing)
- Storage temperature: -20 ... 70 °C (-4 ... +158 °F) (non-condensing)
- Humidity: 5 - 95 % (non-condensing)
- Ambient pressure: Atmospheric pressure
- The protection class is limited to water (no penetrating liquids, detergents or similar aggressive media). Use a protective housing in case of permanent exposure to water.

Optical inputs are excluded from protection class. Contamination leads to impairment or failure of the function.

2. Laser Safety

The sensors of the thicknessSENSOR operate with a semiconductor laser with a wavelength of 670 nm (visible/red).

The sensors fall within Laser Class 2. The lasers are pulsed, the maximum optical power is ≤ 1 mW. The pulse frequency depends on the set measuring rate (0.25 ... 4 kHz). The pulse duration of the peaks is regulated depending on the measuring rate and the reflectivity of the measurement object and can be 0.3 ... 3999.6 μ s.

- **i** Observe the laser protection regulations.

CAUTION

Laser radiation. Irritation or injury of the eyes possible. Close your eyes or immediately turn away if the laser beam hits the eye.

When operating the sensors, the relevant regulations in accordance with DIN EN 60825-1 (VDE 0837, Part 1 dated 07/2015) and the accident prevention instructions on laser radiation (BGV B2 dated 01/1997) valid in Germany must be observed. Thereafter:

- With class 2 laser devices, the eye is not endangered by random, brief exposure to laser radiation, i.e. exposure times of up to 0.25 s.
- Class 2 laser devices may therefore be used without further protective measures if you do not intentionally look into the laser beam or in specularly reflected radiation for more than 0.25 s.
- Because the presence of the eyelid protective reflex should not normally be assumed, one should deliberately close the eyes or turn away immediately if the laser beam hits the eye.

Class 2 laser devices are not subject to notification and a laser protection officer is not required.



Fig. 1 Laser warning signs



Fig. 2 Laser warning symbol

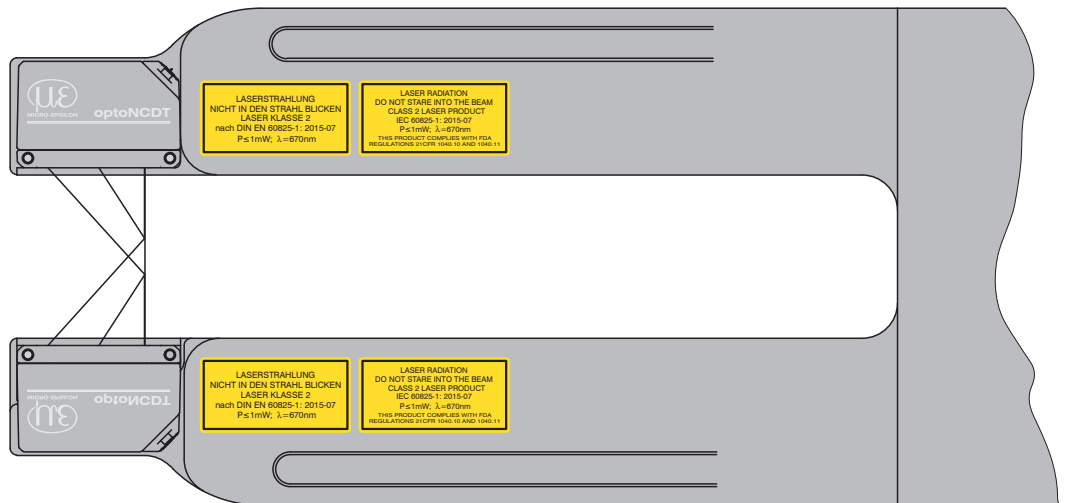

Fig. 3 Laser warning signs on the sensor

- **i** If both warning signs are hidden in the installed state, the user must ensure that additional warning signs are fitted at the point of installation.

The operation of the laser is indicated by an LED on the sensor, see Chap. 5.4.

The housing of the laser-optical sensors may only be opened by the manufacturer, see Chap. 8.

For repair and service purposes the sensors must always be sent to the manufacturer.

3. Functional Principle

3.1 Base Frame

The sensor is used for the non-contact thickness measurement of non-transparent strips and plates.

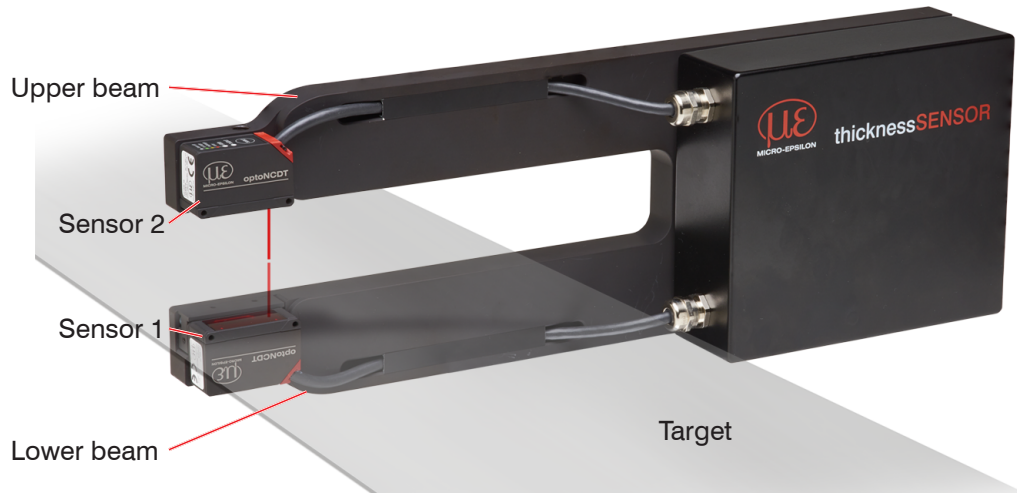

Fig. 4 Schematic representation of the measuring machine

The measuring method of the unit is based on double-sided thickness measurement, consisting of two laser-optical sensors, which measure the target from opposite positions. The thickness of the target is calculated in the integrated controller.

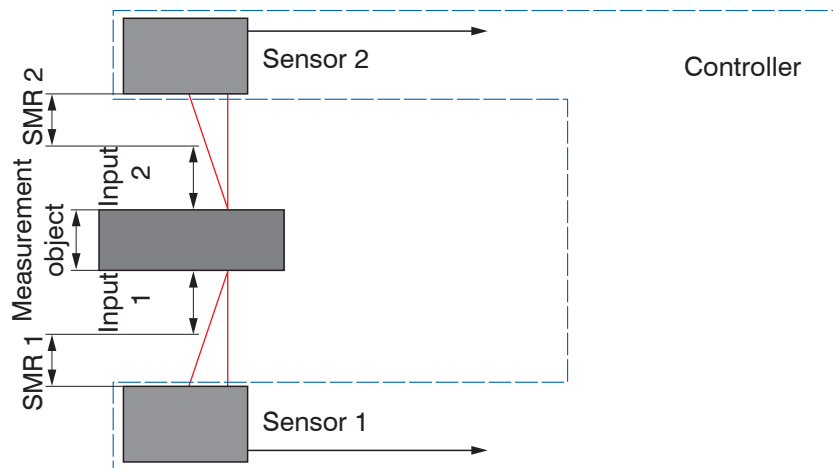

Fig. 5 Sensor arrangement for the thickness measurement

The thickness determination does not require any complex target support. The main advantage is that vibrations of the target do not result in inaccurate measurement. The positional tolerance of the target is determined from the working gap, the start of measuring range (SMR) and the measuring range (MR) of the laser sensors.

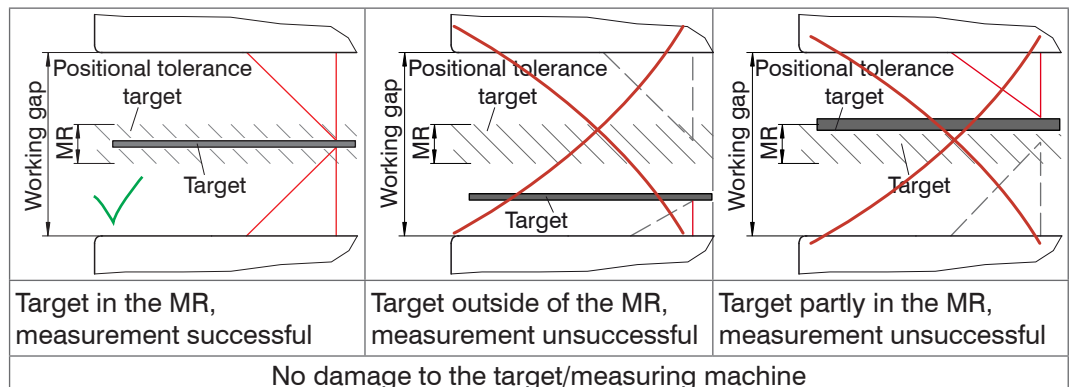

Fig. 6 Possible positions of the material to be measured and statements about the feasibility of thickness measurement

CAUTION

Laser radiation. Irritation or injury of the eyes possible. Close your eyes or immediately turn away if the laser beam hits the eye.

3.2 Sensors

The two laser sensors measure without contact the thickness of the strips as they pass between the two upper and lower belts of the measuring machine, see Fig. 4.

- An air purge at the sensors reduces dust accumulation, etc. on the glass panes for the laser and the receiver.



Fig. 7 Lower belt with laser sensor

3.3 Calibration Target

For a reference measurement, a calibration target is used to detect deviations. The calibration target is 3.0 mm thick, it is attached to the upper belt if required and protrudes into the measuring gap of the sensor. After the reference measurement, the calibration target must be removed again.



Fig. 8 Calibration target on the upper belt

- Calibration measurement is recommended after temperature fluctuations, a mechanical shock of the thicknessSENSOR or after changing the target material.

3.4 Technical Data

Model	thicknessSENSOR 10/200	thicknessSENSOR 10/400	thicknessSENSOR 25/200	thicknessSENSOR 25/400
Measuring range	10 mm	10 mm	25 mm	25 mm
Working gap	46 mm	46 mm	71 mm	71 mm
Measuring width	200 mm	400 mm	200 mm	400 mm
Linearity (combined)	±10 µm	±10 µm	±40 µm	±40 µm
Measuring rate	0.25 kHz / 0.5 kHz / 1 kHz / 2 kHz / 4 kHz			
Light source	Semiconductor laser <1 mW, 670 nm (red)			
Permissible ambient light (±10 %) ¹	20.000 lx			
Light spot diameter max.	65 x 680 µm		80 x 970 µm	
Protection class	IP 65			
Laser safety class	Class 2 according to DIN EN 60825-1: 2015-07			
Temperature stability	± 0.03 % FSO/°C			
Operating temperature	0 ... +50 °C (+32 ... +122 °F) (non-condensing)			
Storage temperature	-20 ... +70 °C (-4 ... +158 °F) (non-condensing)			
Control inputs/outputs	1 x trigger in / 1 x master / 2 x switching outputs			
Measurement value output	0 - 5 V, 0 - 10 V, ±5 V, ±10 V, 4 - 20 mA			
	Ethernet			
Vibration	2 g / 20 ... 500 Hz (according to IEC 60068-2-6)			
Shock	15 g / 6 ms / 3 axes (according to IEC 60068-2-29)			
Weight	3.3 kg	4.3 kg	3.5 kg	4.5 kg
Displays	Sensor	3x color LEDs for power and status		
	Controller	Power i.o.		
Operation	Web interface	Selectable averages / data reduction / setup management / limit values		
Power supply	11 - 30 V DC, 24 V P < 5 W			
Controller	Integrated signal processor, signal processing unit			
Electromagnetic compatibility (EMC)	EN 61 000-6-3 / DIN EN 61326-1 (class B) EN 61 000-6-2 / DIN EN 61326-1			

FSO = full scale output

The specified data apply to a white, diffuse reflecting surface (Micro-Epsilon reference ceramic for ILD sensors)

1) Light spot diameter with line-shaped laser determined based on the emulated 90/10 knife-edge method

4. Delivery

4.1 Unpacking /Included in Delivery

1 thicknessSENSOR

1 instruction manual

x inspection report(s) of the ILD sensors

- ➡ Carefully remove the sensor parts from the packaging and ensure furthermore that the goods are forwarded in such a way that no damage can occur.
- ➡ Check the delivery for completeness and shipping damage immediately after unpacking.
- ➡ In case of damage or missing parts, please contact the manufacturer or supplier immediately.

Optional accessories are available in the appendix, see Chap. [A 1](#).

4.2 Storage

- Storage temperature: -20 ... 70 °C (+32 ... +122 °F) (non-condensing)
- Relative humidity: 5 ... 95 % (-4 ... +158 °F) (non-condensing)

5. Mounting

5.1 General

The thicknessSENSOR achieves linearity in the micrometer range. For this reason, the mechanical components and sensors are matched to one another. Insofar as is constructively possible, mechanical assemblies and individual parts which are not subject to adjustment have been used. Such parts/assemblies which have to be adjusted for functional reasons have been adjusted by Micro-Epsilon.

The commissioning does not require any adjustment work by the customer. The customer is responsible for providing a protective device to avoid a collision between the strip material (target) and the thicknessSENSOR.

5.2 Error Influences

5.2.1 Ambient Light

Thanks to their integrated optical interference filters, the laser-optical sensors offer outstanding performance in suppressing ambient light. However, ambient light disturbances can occur with shiny measurement objects and at a reduced measuring rate. In these cases it is recommended to provide shielding against ambient light. This applies in particular to measurement work performed in the vicinity of welding devices.

5.2.2 Color Differences

Because of intensity compensation, color difference of targets affect the measuring result only slightly. However, such color differences are often combined with different penetration depths of the laser light into the material. Different penetration depths then result in apparent changes of the measuring spot size. Therefore color changes in combination with penetration depth changes may lead to measurement uncertainties.

5.2.3 Surface Roughness

In case of traversing measurements, surface roughnesses of 5 μm and more lead to an apparent distance change (so-called surface noise). However, they can be dampened by selecting a higher average.

5.2.4 Temperature Influences

When the sensor is commissioned, a warm-up time of at least 20 minutes is required to achieve uniform temperature distribution in the sensor. If measurement is performed in the μm accuracy range, the effect of temperature fluctuations on the sensor holder must be considered. Due to the damping effect of the heat capacity of the sensor, sudden temperature changes are only measured with delay.

5.2.5 Movement Blurs

If the objects being measured are fast moving and the measuring rate is low, it is possible that movement blurs may result. Therefore, always select a high measuring rate for high-speed operations to prevent errors.

5.2.6 Optimizing the Measuring Accuracy

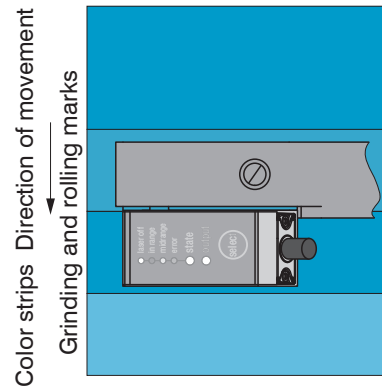

In case of rolled or polished metals that are moved past the sensor, the sensor plane must be arranged in the direction of the rolling or grinding marks. The same arrangement must be used for color strips.

Fig. 9 Sensor arrangement for ground or striped surfaces

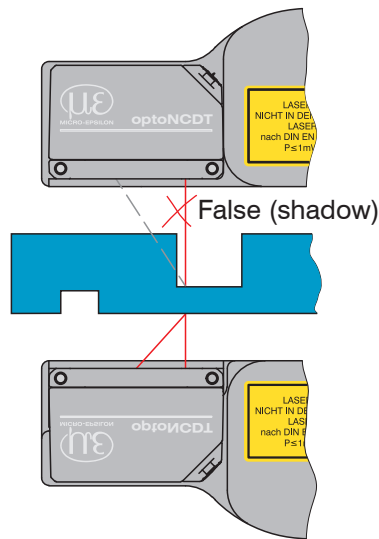

In case of bore holes, blind holes and edges in the surface of moving parts, the sensor must be arranged in such a way that the edge does not obscure the laser spot.

Fig. 10 Sensor arrangement for holes and edges

5.3 Mechanical Fastening, Dimensional Drawing

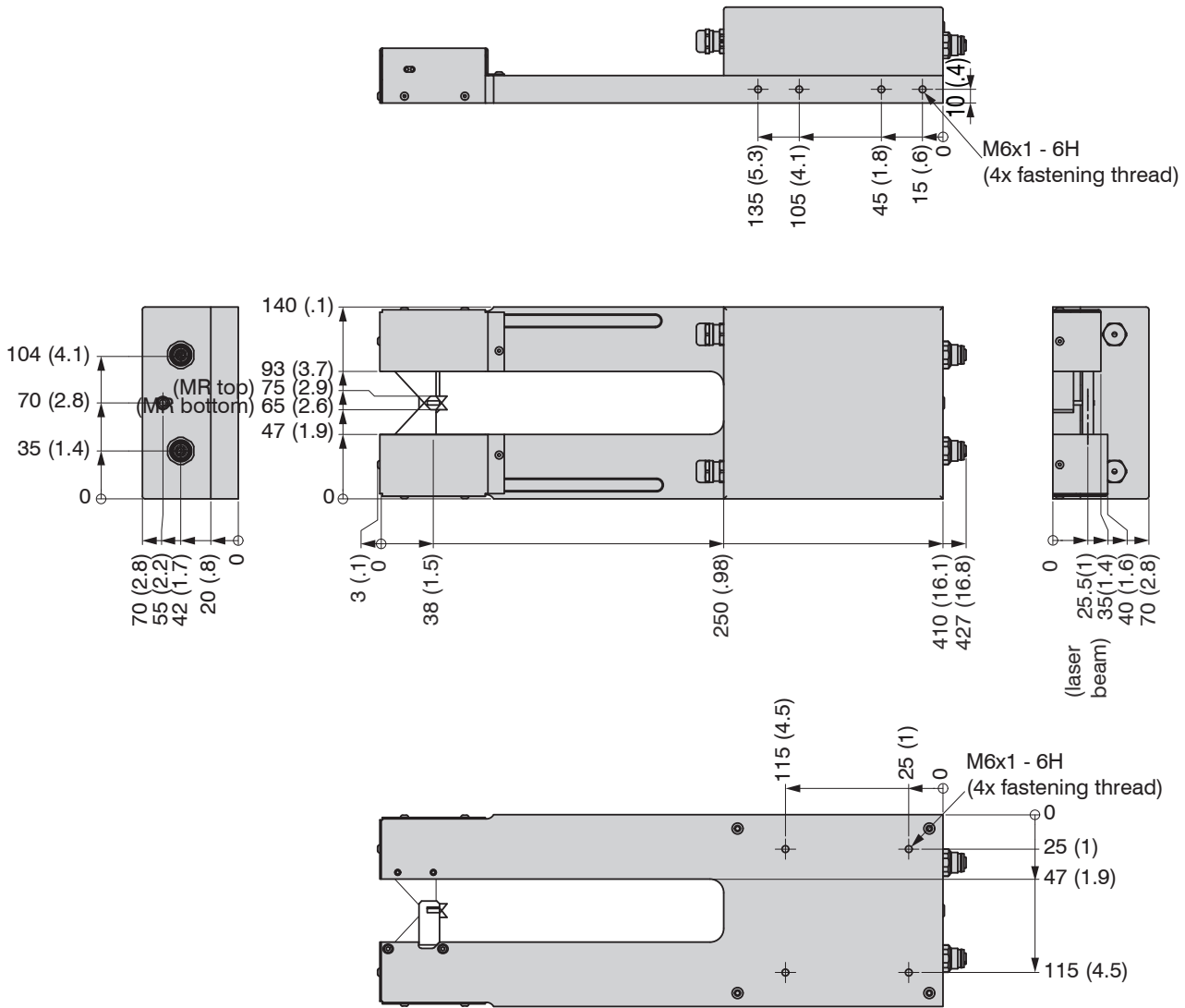

Fig. 11 Dimensional drawing thicknessSENSOR 10/200, dimensions in mm, not to scale

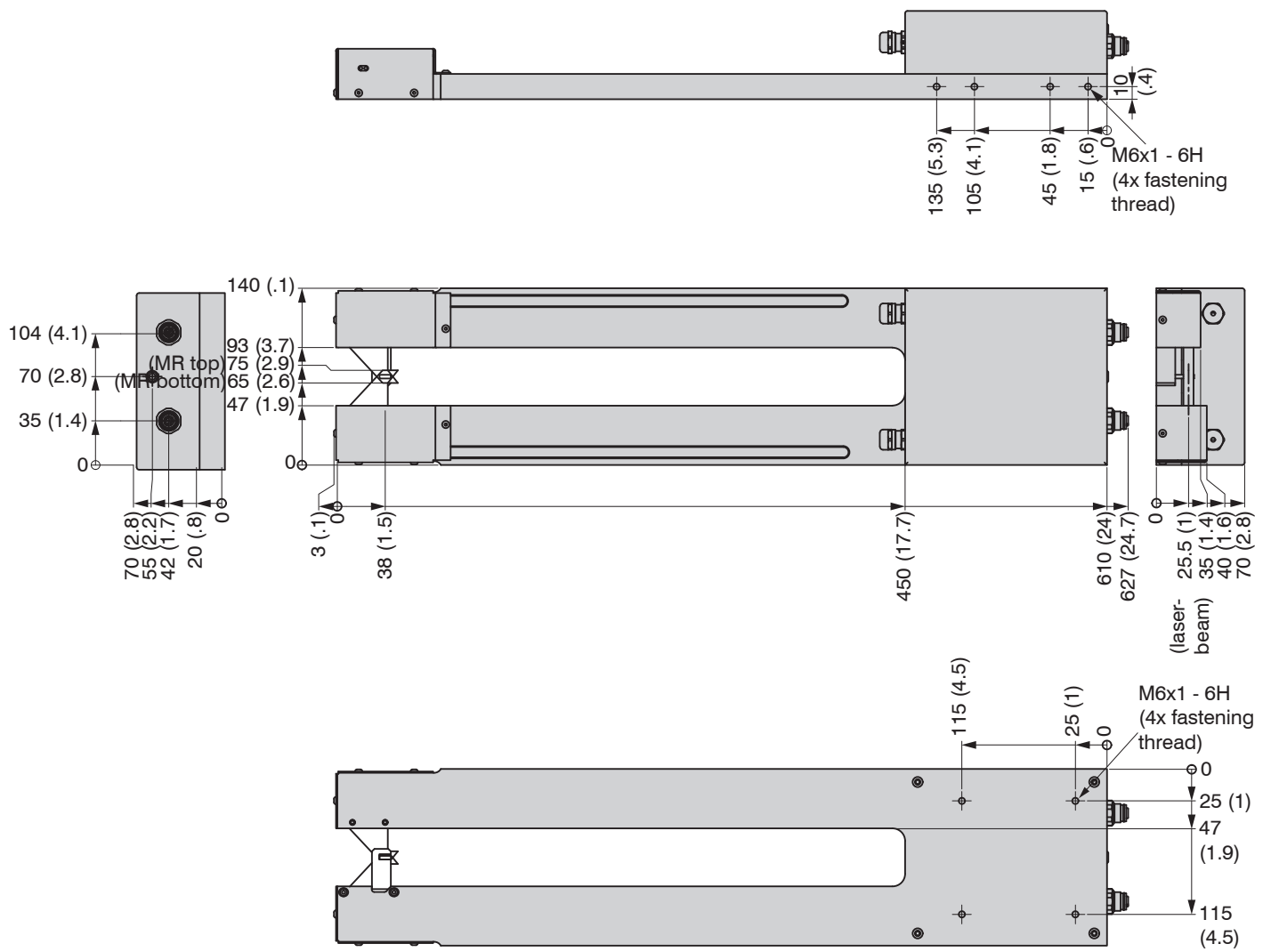

Fig. 12 Dimensional drawing thicknessSENSOR 10/400, dimensions in mm, not to scale

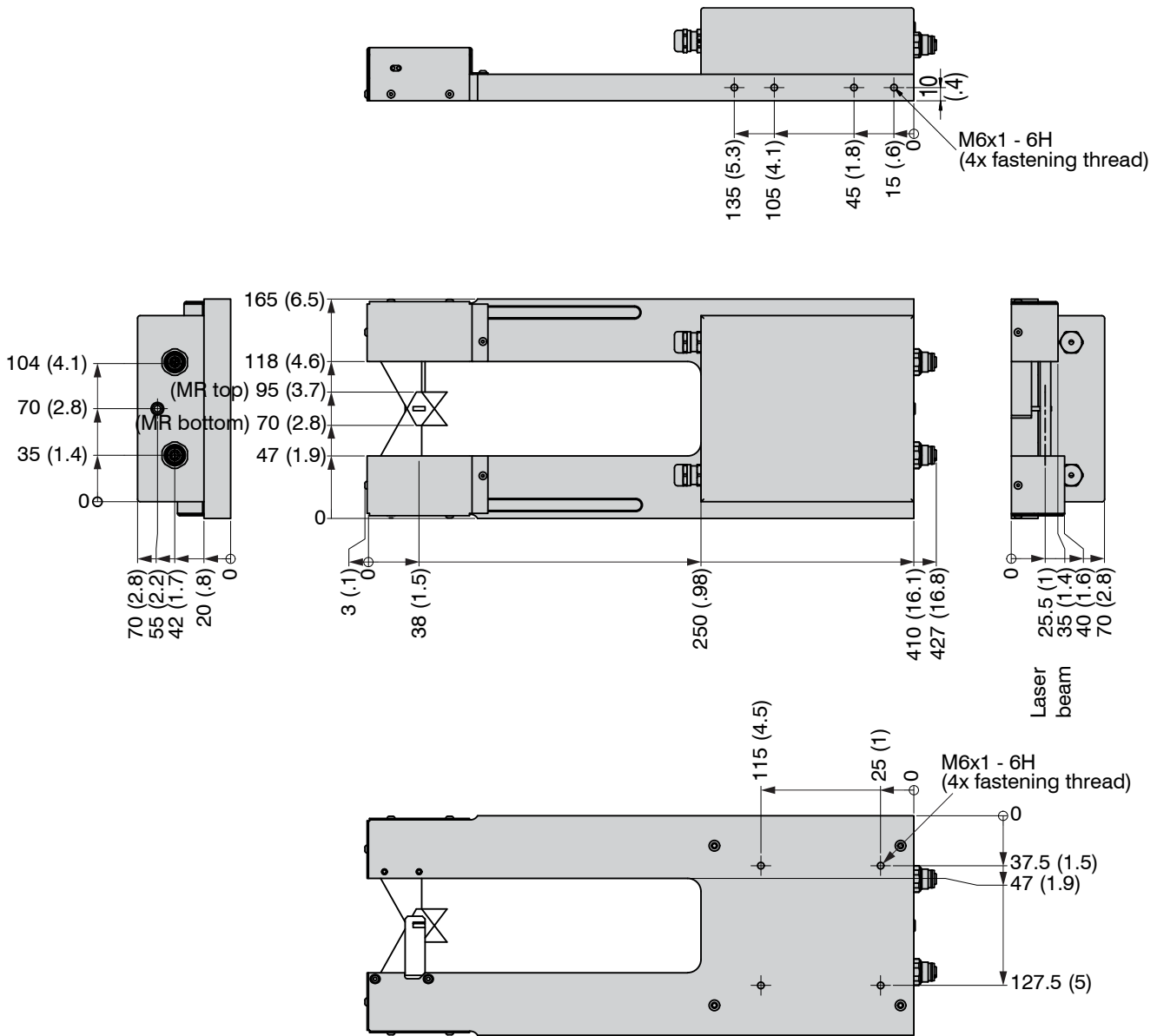

Fig. 13 Dimensional drawing thicknessSENSOR 25/200, dimensions in mm, not to scale

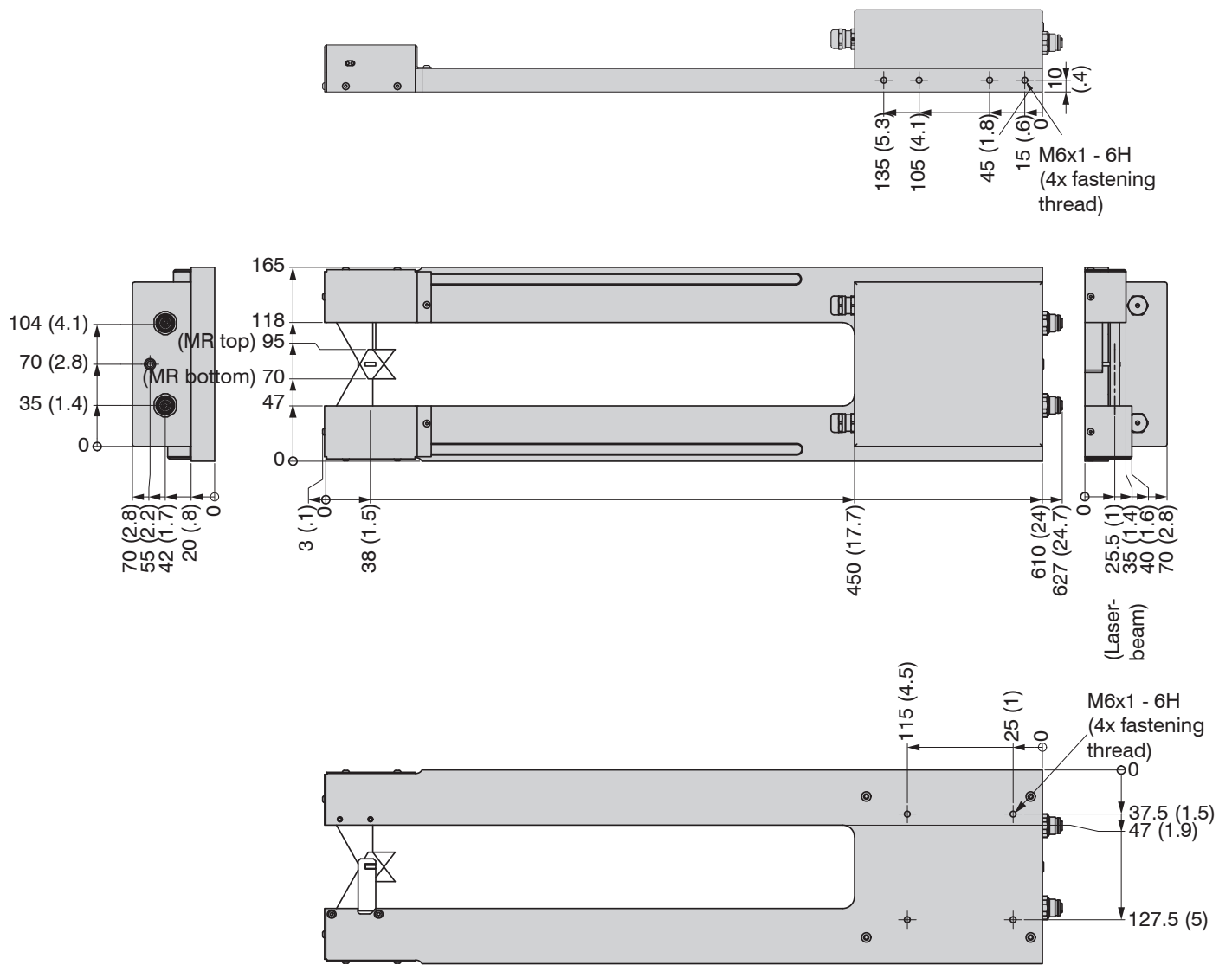
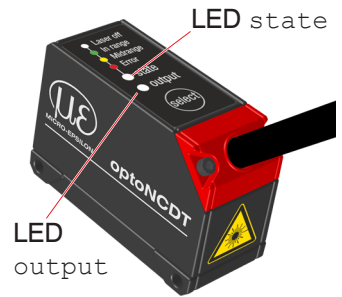

Fig. 14 Dimensional drawing thicknessSENSOR 25/400, dimensions in mm, not to scale

5.4 Control and Display Elements

LED State	Meaning
green	Target within the measuring range
yellow	Target within the midrange
red	Error, e.g. target outside the measuring range, too low reflection
off	Laser switched off
LED Output	Meaning
green	RS422 measured value output
yellow	RS422 and current output are switched off. The RS422 and the current output can be switched on. The web interface can be switched on.
red	Measured value output current 4 ... 20 mA
off	Sensor off, no supply



The `Select` key is disabled.

5.5 Electrical Connections

5.5.1 Connection Possibilities

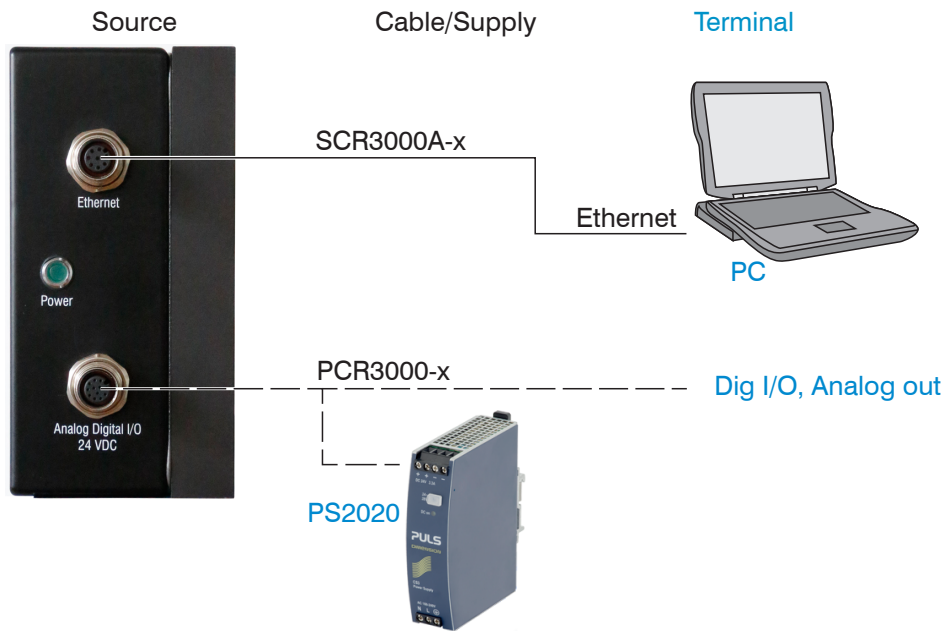
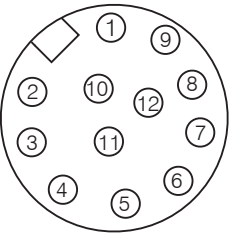

Fig. 15 Connection examples on ILD 1420

Different periphery devices can be connected to the 12-pin Analog Digital I/O 24 VDC connector, see Fig. 15. Power is supplied e.g. by the optionally available power supply PS 2020, see A 1.

5.5.2 Pin Assignment

Pin	Color sensor cable, explanation		Note
9	red	Operating voltage	11 ... 30 VDC, typ. 24 VDC, P < 5 W
2	blue	GND, supply	Power supply ground
3	white	Trigger input	
4	green	Master input	
5	pink	Switching output 1	
6	yellow	Switching output 2	
7	black	GND, switching outputs	
8	gray	Voltage output 1	
10	violet	Voltage output 2	
11	gray-pink	GND, analog	
1	brown	Current output 1	
12	red-blue	Current output 2	
Housing, shield			Connect to potential equalization



Solder side cable connector

Fig. 16 Pin assignment of the 12-pin connector “Analog Digital I/O 24 VDC”

Please refer to the pin assignment diagram for further information, see Chap. A 3.

5.5.3 Power Supply

Nominal value: 24 V DC (11 ... 30 V, P < 5 W).

- Switch on the power supply only after completing the wiring.
- Connect the inputs “9” and “2” at the sensor with a 24V power supply.

Use the power supply unit for measurement devices only and not for drive units or similar sources of pulse interference at the same time.

Sensor		
12-pin M12 cable connector	Sensor cable	
9	red	+U _B
2	blue	GND

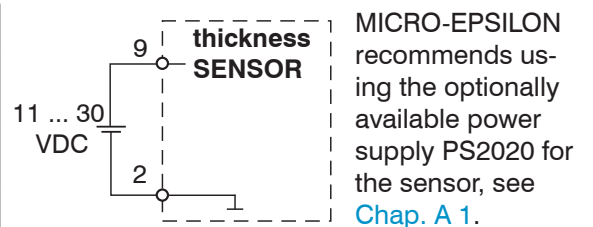

Fig. 17 Power supply connection

5.5.4 Current Output

The sensor provides a current output of 4 ... 20 mA.

I The current output may not be continuously operated in short-circuit operation without load resistor. Permanent short-circuit operation leads to thermal overload and thus to the automatic overload cut-off of the output.

- Connect the output 1 or 12 (brown or red-blue) and 11 (gray-pink) at the sensor with a measurement device.

Sensor		
12-pin M12 cable connector	Sensor cable	
1 or 12	brown or red-blue	I _{OUT1} I _{OUT2}
11	gray-pink	GND

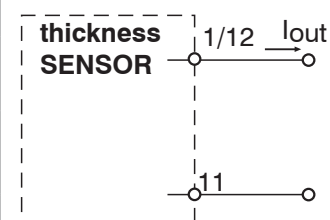

Fig. 18 Wiring for current output

5.5.5 Voltage Output

The sensor provides a voltage output. Variants: 0 ... 5 V, 0 ... 10 V, ± 5 V, ± 10 V.

➡ Connect the output 8 or 10 (gray or violet) and 11 (black) at the sensor with a measurement device.

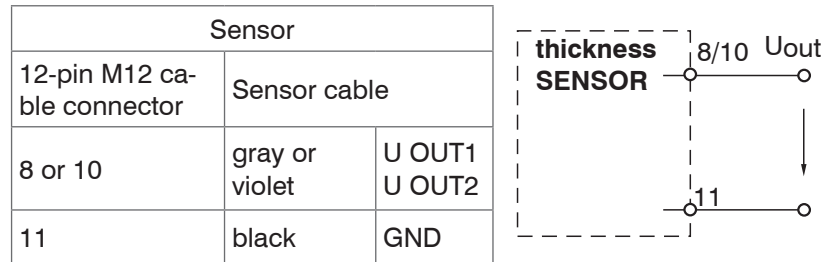

Fig. 19 Wiring for voltage output

5.5.6 Trigger, Master Function Inputs

The inputs on the 12-pin M12 cable connector enable the triggering and zeroing/mastering functions. The function depends on the programming of the input.

- Pin 3 Trigger input
- Pin 4 Zeroing/Master input

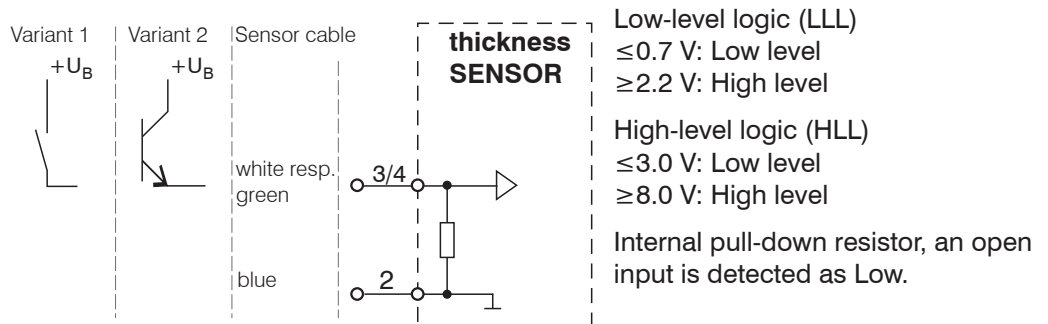

Fig. 20 Basic circuit for the function inputs

➡ Connect the input to $+U_B$ to trigger the function.

5.5.7 Switching Outputs

The switching characteristic of the push-pull error outputs on the 12-pin M12 cable connector depends on the programming.

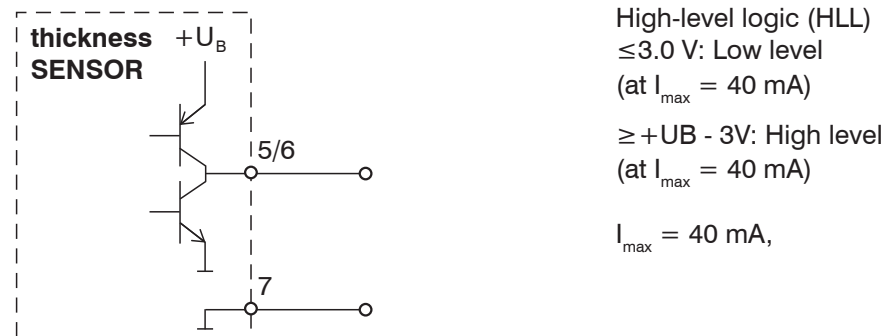

Fig. 21 Basic circuit for the error output

Switching characteristic		
Description	Output active (error)	Output passive (no error)
Push-Pull	$+ U_B - 3V$ (at $I_{max} = 40$ mA)	≤ 3.0 V (at $I_{max} = 40$ mA)

Fig. 22 Switching characteristic for error output

Error output is activated e.g. when the measurement object is missing, it is too close/too far or when no valid measurement value can be determined.

5.5.8 Connector and Sensor Cable

- Never fall below the bending radius for the sensor cable of 30 mm (fixed) resp. 60 mm (dynamic).
- Unused open cable ends must be insulated or bluntly cut to protect against short circuits or sensor malfunctions.
- Avoid excessive pull on the cables. If a cable of over 5m in length is used and it hangs vertically without being secured, make sure that some form of strain relief is provided close to the connector.
- Connect the cable shield to the potential equalization (PE, protective earth conductor) on the evaluator (switching cabinet, PC housing) and avoid ground loops.
- Never lay signal leads next to or together with power cables or pulse-loaded cables (e.g. for drive units and solenoid valves) in a bundle or in cable ducts. Always use separate ducts.

Recommended strand cross-section for self-made connection cables: $\geq 0.14 \text{ mm}^2$.

6. Operation

6.1 Getting Ready for Operation

- Mount the thicknessSENSOR according to the installation instructions, see Chap. 5.3.
- Connect the thicknessSENSOR to downstream display or monitoring units and to the power supply.

The laser diode in the sensors is activated by the controller.

Once the operating voltage has been switched on, the thicknessSENSOR runs through an initialization sequence. This is indicated by the momentary activation of all the LEDs. The initialization takes up to 10 seconds.

The thicknessSENSOR typically requires a start-up time of 20 min for reproducible measurements.

If the LED `Output` is off, this means that there is no operating voltage

If the LED `State` is off, this means that the laser light source has been switched off.

i The controller can only be operated via the web interface. The last setting applies.

6.2 Operation Using Ethernet

Dynamic web pages are generated in the thicknessSENSOR which contain the current settings of the thicknessSENSOR and the peripherals. Operation is only possible while there is an Ethernet connection to the thicknessSENSOR.

6.2.1 Requirements

You need a current web browser (e.g. Google Chrome or Mozilla Firefox) on a PC with a network connection. Decide whether the thicknessSENSOR should be connected to a network or directly to a PC.

The thicknessSENSOR is supplied as standard with a fixed IP address. If you do not want a static IP address, you can enable DHCP (Dynamic Host Configuration Protocol) for automatic IP addressing. The thicknessSENSOR is then assigned an IP address by your DHCP serve, see Chap. 6.2.2.

If you have configured your browser so that it accesses the Internet via a proxy server, please add the IP address of the thicknessSENSOR in the browser settings to the list of addresses which should not be routed via the proxy server.

Parameters	Description
Address type	Static IP address (standard) or dynamic IP address (DHCP)
IP address	Static IP address of the controller (only active if DHCP has not been selected)
Subnet mask	Subnet mask of the IP subnet
Gateway	Gateway to other subnets

Fig. 23 Ethernet basic settings

“Javascript” must be enabled in the browser so that measurement results can be displayed graphically.

6.2.2 Access via Ethernet

Direct connection with PC, thicknessSENSOR with static IP address (factory setting)		Network
PC with static IP address	PC with DHCP	Controller with dynamic IP address, PC with DHCP
<p>➤ Connect the thicknessSENSOR (“Ethernet” socket) to the PC using a direct Ethernet connection (LAN). Use a LAN cable with a 7-pin M12 cable connector and an RJ-45 connector.</p>		<p>➤ Connect the thicknessSENSOR to a switch using a direct Ethernet connection (LAN). Use a LAN cable with a 7-pin M12 cable connector and an RJ-45 connector.</p>
<p>The thicknessSENSOR needs a fixed IP address to establish a direct connection.</p> <p>➤ Start the program <code>sensorTOOL</code>.</p> <p>You can find it online at https://www.micro-epsilon.com/download/software/sensorTOOL.exe.</p> <p>➤ Click the <code>Sensor</code> button. Select the required sensor from the list.</p> <p>➤ Click on the <code>Open Website</code> button to connect the sensor to your standard browser.</p>	<p>Wait until Windows has established a network connection (connection with limited connectivity).</p> <p>➤ Start the program <code>sensorTOOL</code>.</p> <p>You can find it online at https://www.micro-epsilon.com/download/software/sensorTOOL.exe.</p> <p>➤ Click the <code>Sensor</code> button. Select the required sensor from the list.</p> <p>➤ Click on the <code>Open Website</code> button to connect the sensor to your standard browser.</p>	<p>➤ Enter the sensor in the DHCP server / notify the sensor to your IT Department.</p> <p>The sensor is assigned an IP address by your DHCP server. You can query this IP address with the program <code>sensorTOOL</code>.</p> <p>➤ Start the program <code>sensorTOOL</code>.</p> <p>You can find it online at https://www.micro-epsilon.com/download/software/sensorTOOL.exe.</p> <p>➤ Click the <code>Sensor</code> button. Select the required sensor from the list.</p> <p>➤ Click on the <code>Open Website</code> button to connect the sensor to your standard browser.</p>

Interactive web pages for programming the thicknessSENSOR and peripherals are now shown in the web browser.

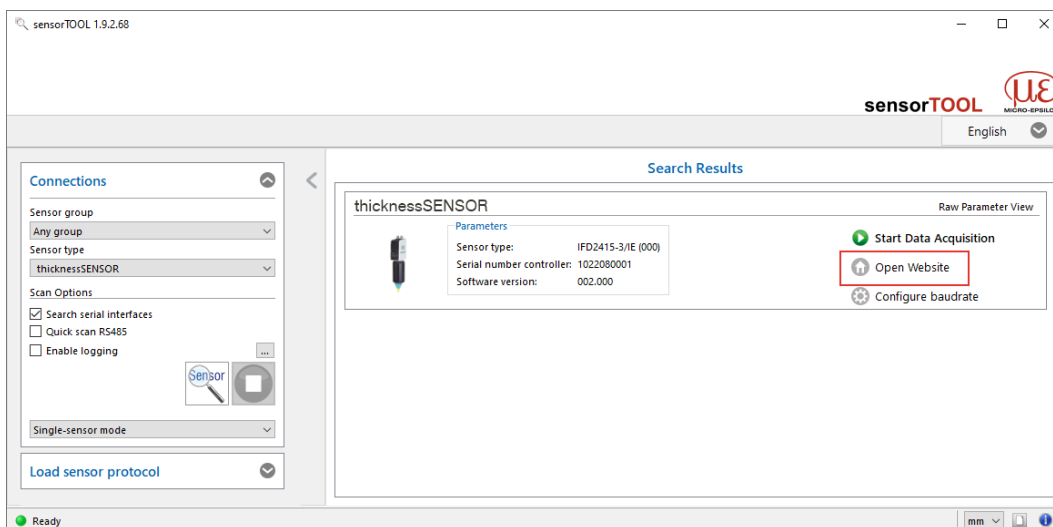

Fig. 24 sensorTOOL auxiliary program for finding sensors and starting the web interface

Parallel operation with web browser and ASCII commands is possible; the last setting applies. Do not forget to save.

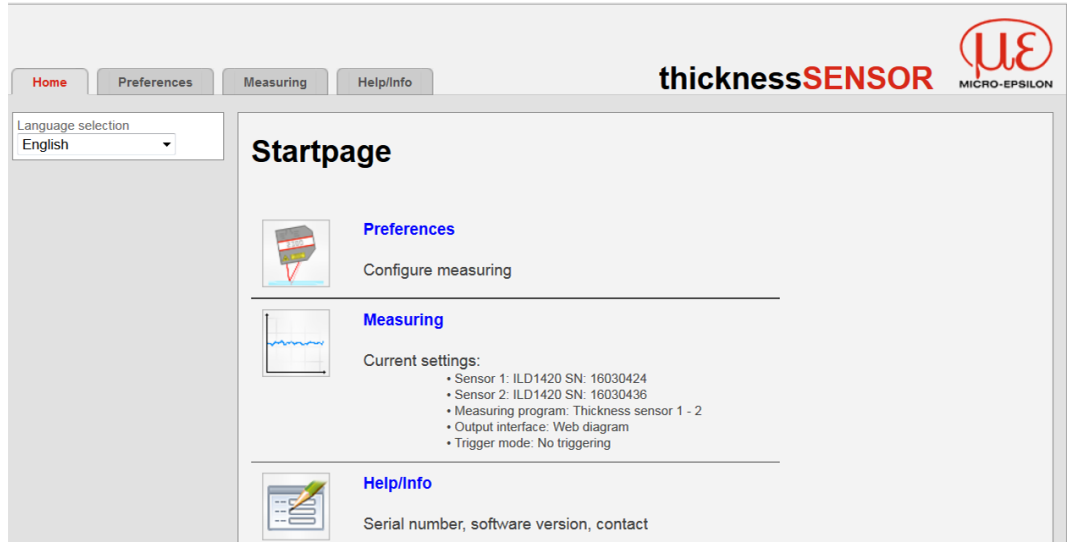

Fig. 25 First interactive web page after calling the IP address

Use the upper navigation bar to access additional features (Preferences, Measuring and Help/Info).

All settings in the web page are implemented immediately after pressing the `Apply` button.

The appearance of the web pages can change depending on the functions and the peripherals. Each page contains parameter descriptions and tips on completing the web page.

Additional submenus can be accessed via the left-hand navigation column of the web pages, e.g. measuring rate or trigger mode.

i When programming has been completed, store all settings permanently in a set of parameters to ensure that these settings are available when the sensor is switched on the next time.

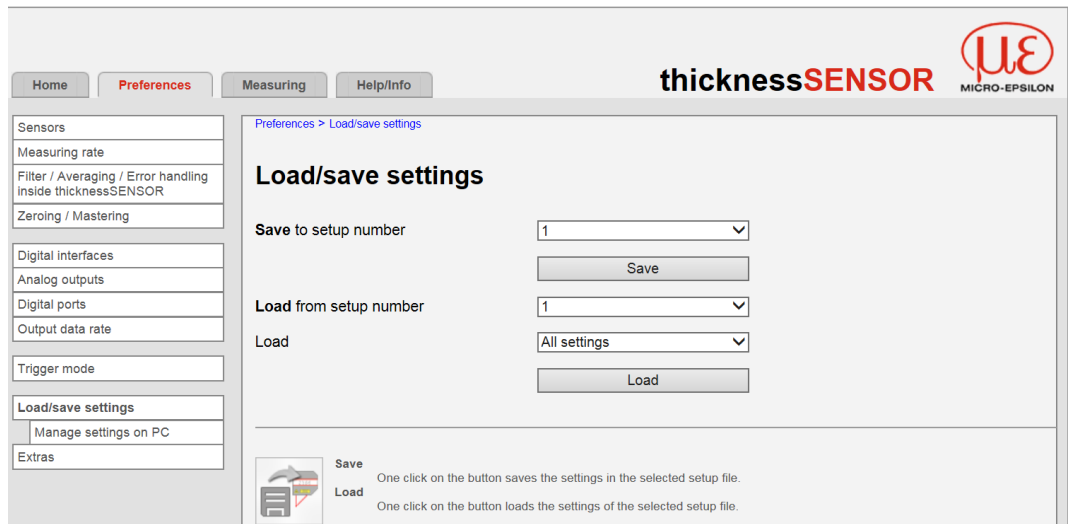

Fig. 26 Menu structure in the Preferences tab

6.2.3 Measured Value Display with Web Browser

“Javascript” must be enabled in the browser so that measurement results can be displayed graphically.

➔ Start the measured value display (Measuring) in the horizontal navigation bar.

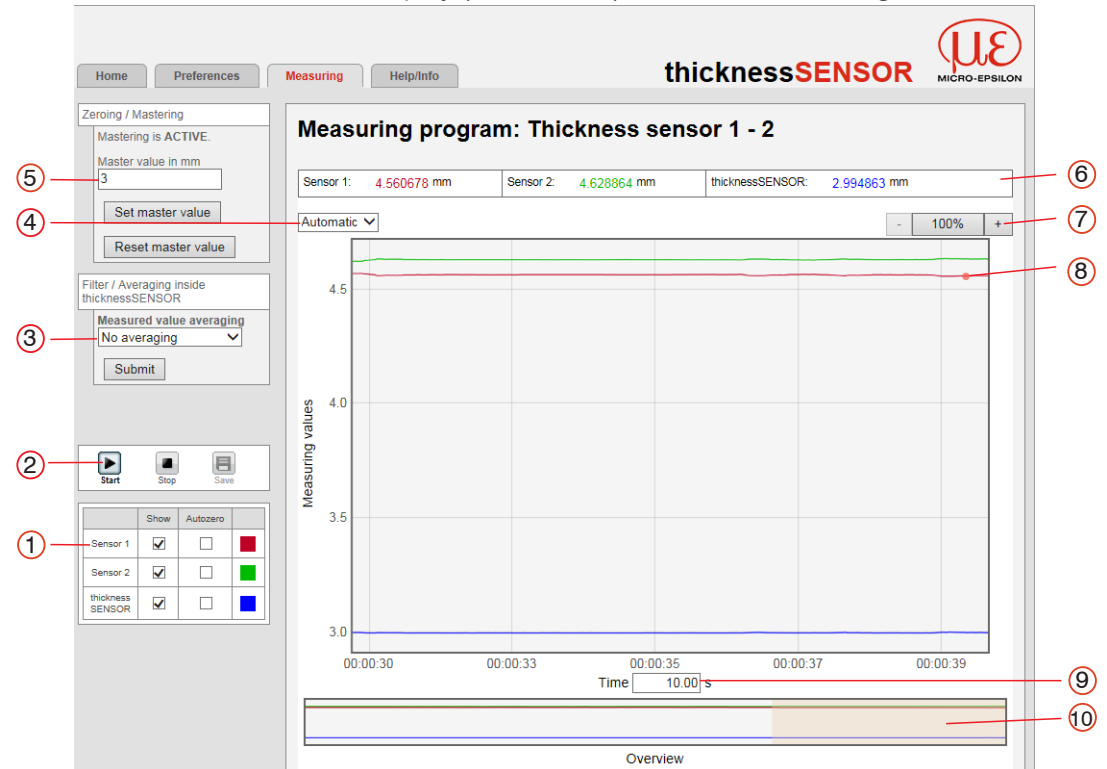

Fig. 27 Display of the measurement and calculation results

- 1 Each curve can be deactivated and activated using the associated checkbox (checkmark). The Autozero function starts or stops a relative measurement for the thickness result.
- 2 Stop stops the diagram; data selection and zoom function are still possible. Save creates a CSV file (separation with semicolon) to store the last (approx. 50000) measured values. The file contains the accumulated measurement and calculation results including time information. The file is stored in the download area under Windows.
- 3 Averaging only affects the thickness result (thicknessSENSOR value); no averaging takes place in the laser sensors. The setting of the averaging can be carried out in parallel in the Preferences menu.
- 4 For scaling the measured value axis (y-axis) of the graphic, you can either select Auto (= autoscaling) or Manual (= manual setting).

Enable automatic scaling:

➔ Select Automatic from the drop-down menu.

Enable manual scaling:

➔ Select Manual from the drop-down menu.

The lowest and highest value of the scaling of the y-axis is automatically displayed.

The y-axis can be scaled manually.

- 5 The master value is used to specify the thickness of a measurement object. Use the Set master value button to set the thickness result to zero, for example, if you want to make a differential measurement. The function is also used for a calibration measurement, see Chap. 3.3.
- 6 The current values of the two laser sensors and the calculated thickness value (thicknessSENSOR value) are displayed in the text boxes above the graphic.

- 7 The zoom function scales the time axis during both the measurement and the offline analysis.
 - 8 Mouseover function. When moving the mouse over the graphic in stopped state, curve points are marked with a circle symbol and the related values are displayed in a text box above the graphic.
 - 9 Scaling of the x-axis can be defined by means of an input field below the time axis.
 - 10 Scaling of the x-axis: When the measurement is running, you can use the left slider to enlarge (zoom) the total signal. If the diagram is stopped, you can also use the right slider. The zoom window can also be moved with the mouse in the center of the zoom window (arrow cross).
- By letting the diagram display run in a separate tab or browser window, you do not have to restart the display every time.

If the language is set to German, the measured values are stored with a comma as a decimal separator, otherwise with a period.

NOTICE

Only a limited number of recorded measurements can be stored (about 50,000). If more measured values are recorded, the oldest measured values are deleted.

• With high data rates, only a reduced number of measured values are displayed in the diagram!

6.3 Home Menu

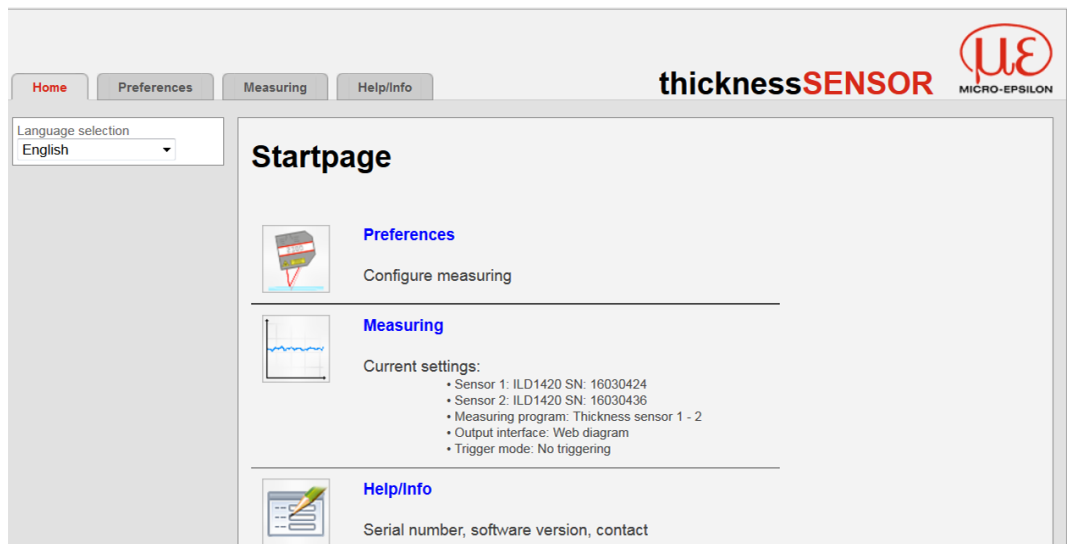

Fig. 28 Start page screen

The Home menu is the first interactive web page after calling the IP address.

On the left side you can select the language from the Language selection drop-down menu, see Fig. 28. The language selection can also be made via the Preferences > Extras > Language menu, see 6.4.1.

The upper navigation bar can be used to access additional features (Preferences, see Chap. 6.4, Measuring, and Help/Info, see Chap. 6.6).

6.4 Preferences Menu

6.4.1 Language Selection

➡ Go to the Preferences > Extras > Language menu.

This menu item allows you to change the language of the interactive web pages.

Language selection	System / English / German	Language of the interactive web pages
--------------------	---------------------------	---------------------------------------

The language selection can also be made via the Home > Language selection menu, see Chap. 6.3.

6.4.2 Sensors

➡ Go to the Preferences > Sensors menu.

Sensors	Sensor 1 / Sensor 2	Connected sensor	ILD1420 SN xxxxxxxx	Controller reads the serial numbers of the sensors used. A selection is not possible.
		Search for connected sensors	Search sensors	If no sensor is listed, it is possible to search for sensors.
	Peak selection	Available peaks	Highest peak / first peak / last peak Submit peak	Defines which signal is used in the array signal for the evaluation. Highest peak: Standard, peak with the highest intensity. First peak: Nearest peak to sensor. Last peak: Peak furthest away from sensor.
	Selection of the measurement task	Available measurement tasks	Standard / changing surfaces / material with penetration Submit measurement task	The selection of a measurement task loads a predefined sensor configuration that produces the best results for the selected material.
	Laser	Laser is ON. Laser is OFF.	Switch off the laser Switch on the laser	Switches the laser light source on or off at the sensor on the software side.

Fig. 29 Preferences - Sensors screen

Standard	Suitable for materials made of ceramic, metal or filled plastics
Changing surfaces	Suitable for circuit boards (PCB) or hybrid materials
Material with penetration	Suitable for plastics (POM, Teflon), materials with strong penetration depth of the laser

Fig. 30 Overview of measurement task selection - Available measurement tasks

 Fields with a gray background require a selection.

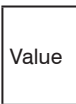
 Value
Dark bordered fields require the specification of a value.

6.4.3 Measuring Rate

➡ Go to the Preferences > Measuring rate menu.

The measuring rate indicates the number of measurements per second.

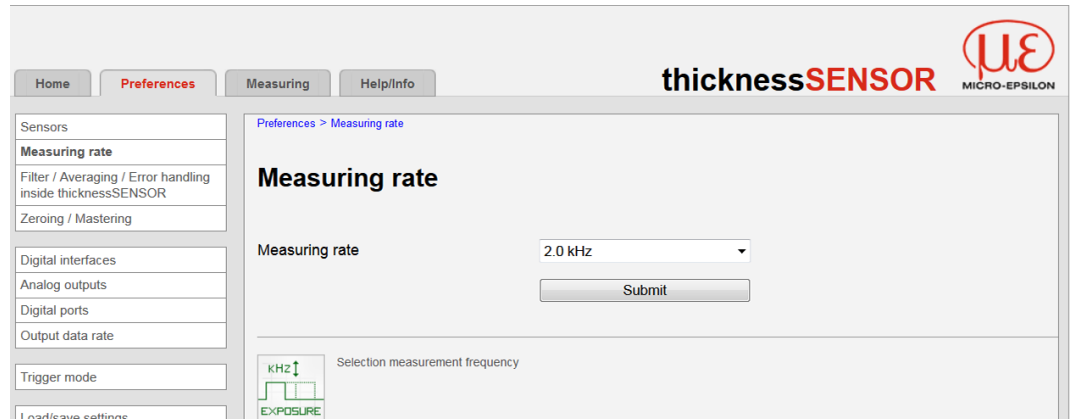

➡ Select the required measurement frequency.

Measuring rate	0.5 kHz / 1.0 kHz / 2.0 kHz / 4 kHz	Use a high measuring rate for bright and mat measurement objects. Use a low measuring rate for dark or shiny measurement objects (e.g. black painted surfaces) to improve the measurement result.
----------------	-------------------------------------	---

The measurement frequency is factory set to 2 kHz.

 Fields with a gray background require a selection.

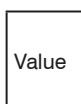
 Dark bordered fields require the specification of a value.

6.4.4 Filter / Averaging / Error Handling Inside thicknessSENSOR

➡ Go to the Preferences > Filter / Averaging / Error handling inside thicknessSENSOR menu.



A number of filter types for measurement values are available. Filtering lowers the noise of the measurement signal which results in a better resolution. Filter width is used to specify the number of measurement values to which the filter applies.

Filter / Averaging / Error handling inside thicknessSENSOR	Measured value averaging	<i>No averaging</i>	
		<i>Moving average for N values / Recursive average for N values / Median filter for N values</i>	Number of values for moving average: 2 / 4 / 8 / 16 / 32 / 64 Number of values for recursive average: / 128 / 256 / Number of values for median filter: 512
		Error handling in the case of no valid measured value	Error output, no measurement / Hold last valid value / Hold last valid value forever If no valid measured value can be determined, an error value is output. If this impedes further processing, the last valid measured value can be kept for a number of measurement cycles, i.e. output repeatedly.

Moving average:

The selectable filter width N for successive measured values is used to calculate and issue the arithmetic average M_{gl} . Each new measured value is added, the first (oldest) measured value is removed from the averaging.

$$M_{gl} = \frac{\sum_{k=1}^N MW(k)}{N}$$

MW = measured value
 N = averaging number
 k = continuous index (in the window)
 M_{gl} = average or output value

Each new measured value is added, the first (oldest) measured value is removed from the averaging (from the window) again. In this way, short settling times for measured value jumps are achieved.

Example: $N = 4$

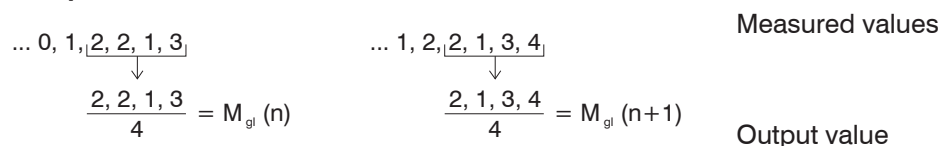

i Moving average in the controller of the thicknessSENSOR allows only potentials of 2 for the averaging number N. The highest averaging number is 1024.

Fields with a gray background require a selection.

Value
Dark bordered fields require the specification of a value.

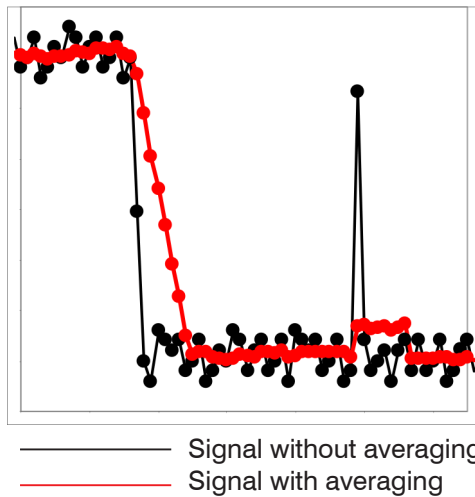

Fig. 31 Moving average, $N = 8$

Recursive average

Formula:

$$M_{rek}(n) = \frac{MW_{(n)} + (N-1) \times M_{rek(n-1)}}{N}$$

MW = measured value

N = averaging value, $N = 1 \dots 32768$

n = measured value index

M_{rek} = average or output value

The weighted value of each new measured value $MW(n)$ is added to $(n-1)$ times the previous average.

The recursive averaging enables very strong smoothing of the measured values, however it needs very long settling times for measured value jumps. The recursive average shows low-pass behavior.

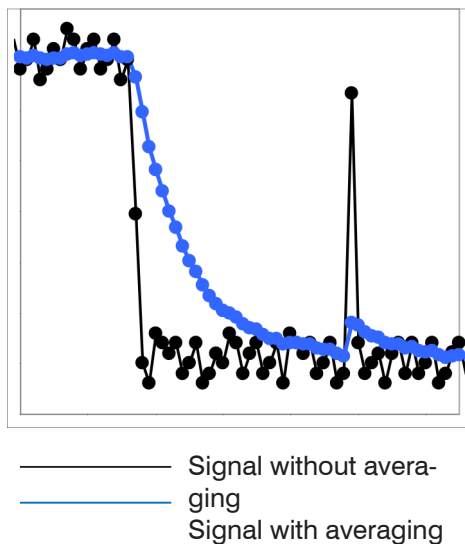

Fig. 32 Recursive average, $N = 8$

Median:

The median is formed from a preselected filter width N for measurement values. The incoming measured values are also sorted again after each measurement. Afterwards, the average value is output as the median. If an even number is selected as filter width N , the two average measurement values are added and divided by two.

3, 5, 7 or 9 readings are taken into account. This means that individual interference pulses can be suppressed. However, the smoothing of the measured value curves is not very strong.

Application tips

- Smoothing of measured values
- The effect can be finely measured in comparison to the recursive averaging.
- With uniform noise of the measured values without spikes
- For a slightly rough surface, in which the roughness is to be eliminated.
- Also suitable for measured value jumps at relatively short settling times.

Application tips

- Allows very strong smoothing of the measured values. Long settling times for measured value jumps (low-pass behavior)
- Strong smoothing of noise without large spikes
- For static measurements, to smooth the signal noise particularly strongly
- For dynamic measurements on rough target surfaces to eliminate the roughness, e.g. paper roughness on paper webs
- For the elimination of structures, e.g. parts with uniform groove structures, knurled turned parts or coarse milled parts
- Not suitable for high-dynamic measurements

Example: Median value from five measured values

... 0 1 2 4 5 1 3 → Sorted measurement values: 1 2 **3** 4 5 Median_(n) = 3
 ... 1 2 4 5 1 3 5 → Sorted measurement values: 1 3 **4** 5 5 Median_(n+1) = 4

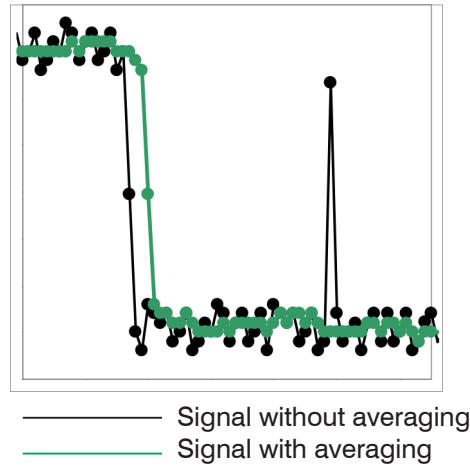

Application tips

- Smoothing of the measured value curve is not very strong, used to eliminate outliers
- Suppresses individual interference pulses
- In short, strong signal peaks (spikes)
- Also suitable for edge jumps (only minor influence)
- For rough, dusty or dirty environment, to eliminate dirt or roughness
- Further averaging can be used after the median filter

Fig. 33 Median, N = 7

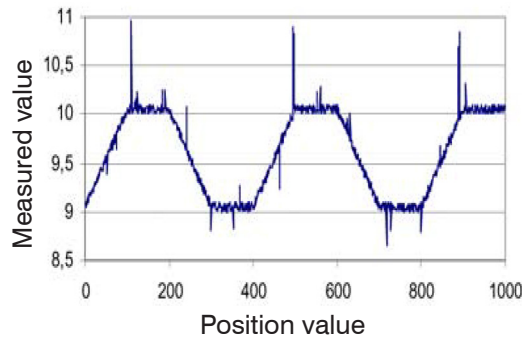

Fig. 34 Original profile

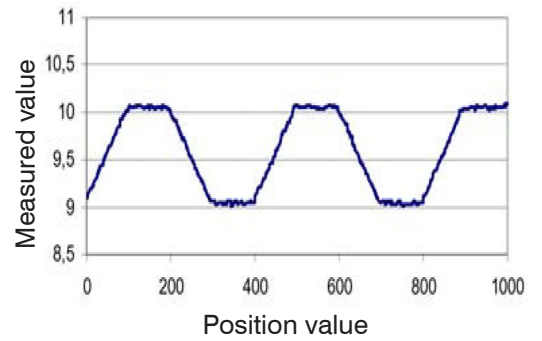

Fig. 35 Profile with median, N = 9

6.4.5 Zeroing / Mastering

➡ Go to the Preferences > Zeroing / Mastering menu.

Zeroing / Mastering	Mastering is ACTIVE	Reset master value	Reset zero setting and mastering.
	Mastering is INACTIVE	Set master value	Activate zero setting and mastering. Value range for mastering: from -1024 to 1024 mm.
	Master value in mm	Value	

Fields with a gray background require a selection.

Value
Dark bordered fields require the specification of a value.

6.4.6 Digital Interfaces

6.4.6.1 Selection of Digital Interfaces

➡ Go to the Preferences > Digital interfaces > Digital interface selection menu.

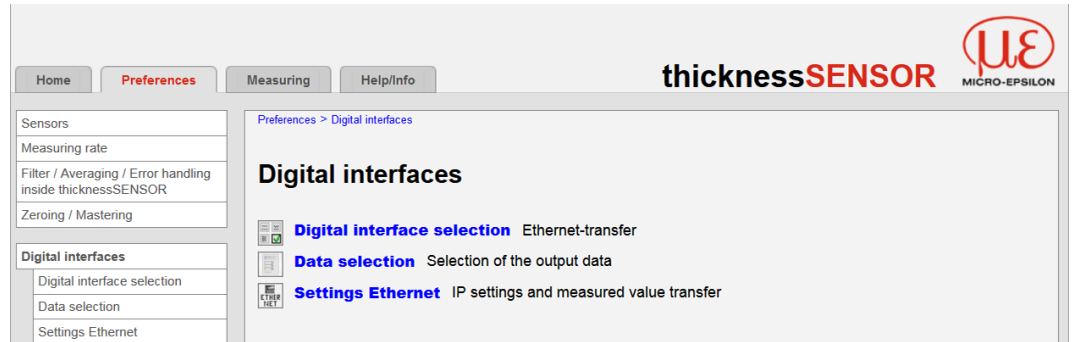

Digital interfaces	Selection of digital interfaces	Interface used for data output	<i>Disabled</i>	No measured values are output via the digital interface.
			<i>Ethernet transmission of measured values</i>	Ethernet enables fast, non-real-time data transmission (packet-based data transfer). The measurement device can be configured via the web interface or by ASCII commands via a terminal program, see Chap. A 4 . Go to Ethernet settings, see Chap. 6.4.6.3 .
			<i>Web diagram</i>	The recorded measured values are displayed in a diagram on the Measuring web page, see Chap. 6.5 .

i The Ethernet interface is recommended for a measured value output with subsequent analysis without direct process control. If a real-time measured value output is necessary for process control, the analog interfaces should be used.

6.4.6.2 Data Selection

 Fields with a gray background require a selection.

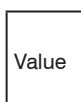
 Value
Dark bordered fields require the specification of a value.

➡ Go to the Preferences > Digital interfaces > Data selection menu.

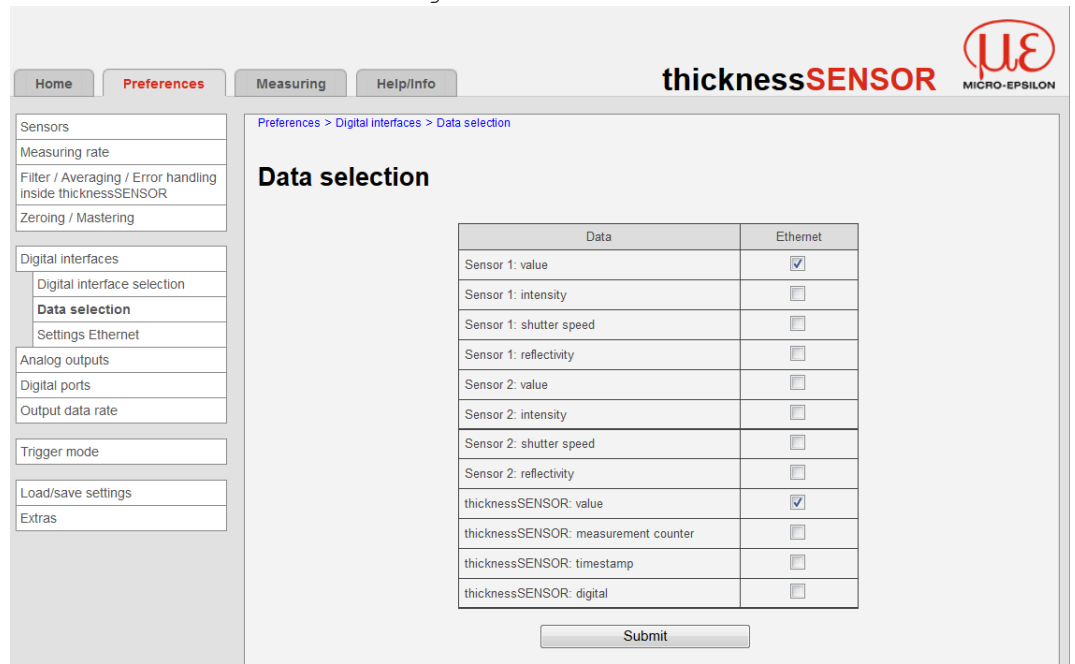

Fig. 36 Digital interfaces - Data selection screen

Here you can select data for transmission via digital interfaces.

From the sum of all available data those which are required for further processing can be selected. This data is then output one after the other in a defined sequence. You will find information about the data format, the output sequence and more details in the MEDAQLib instruction manual of MICRO-EPSILON, see Chap. 7.

i The display and storage of additional values is not possible in the web diagram.

Please use the thicknessSENSOR tool, which is available on request.

6.4.6.3 Ethernet Settings

➡ Go to the Preferences > Digital interfaces > Settings Ethernet menu.

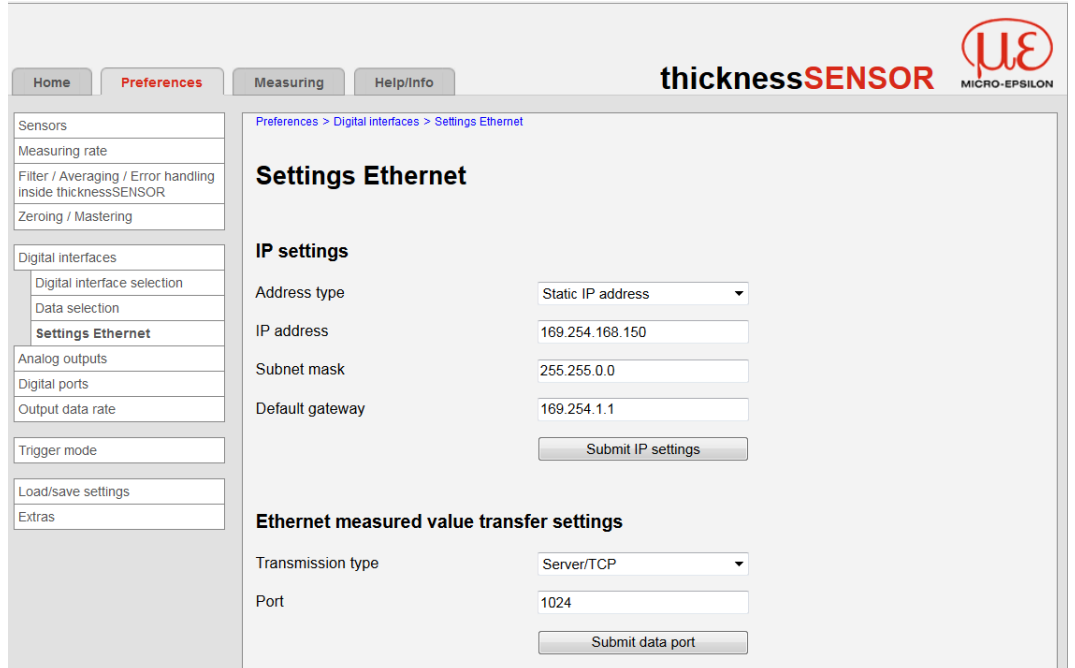



Fig. 37 Ethernet settings screen

Ethernet settings	IP settings	Address type	Static IP address / DHCP	
		IP address	<i>Value</i>	Values for IP address / gateway / subnet mask. Only for static IP address
Subnet mask	<i>Value</i>			
Default gateway	<i>Value</i>			
	Ethernet measured value transfer settings	Transmission type	Server/TCP	The thicknessSENSOR provides the measured values as a server (transmission type: Server/TCP).
		Port	<i>Value</i>	

The thicknessSENSOR provides the measured values as a server (transmission type: Server/TCP). A self-written program or a tool such as ICONNECT can be used as client. You will find the documentation of the data format in the MEDAQLib instruction manual of MICRO-EPSILON, see Chap. 7.

6.4.7 Analog Outputs

 Fields with a gray background require a selection.

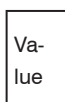
 Dark bordered fields require the specification of a value.

➔ Go to the Preferences > Analog outputs menu.



6.4.7.1 Analog Output 1 and 2

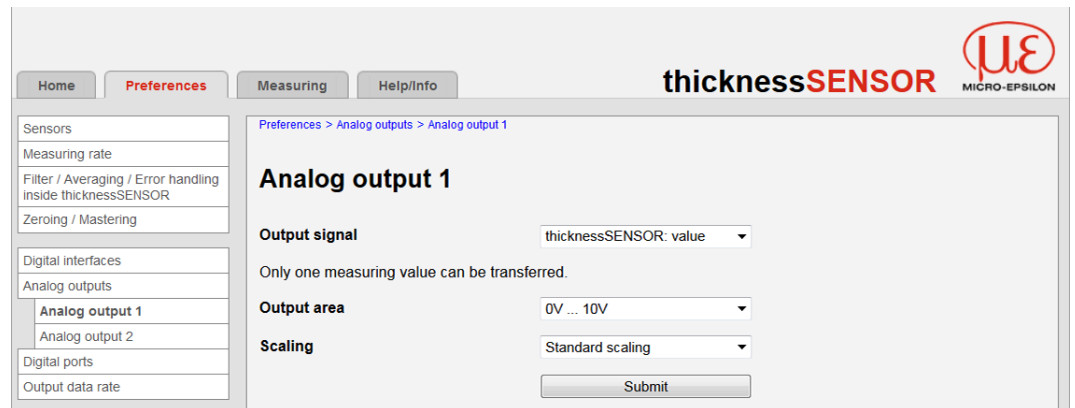

Fig. 38 Preferences - Analog outputs screen

You can adjust the output signal, the output value, the output area and the scaling in this screen. After setting in the Measured value averaging menu, see Chap. 6.4.4, no averaging, you can select in the Analog outputs> Output signal menu between Fixed output value, Sensor 1 value and Sensor 2 value, see Fig. 39.

After setting in the Measured value averaging menu, see Chap. 6.4.4, an averaging method or the median filter, you must set in the Analog output > Output signal menu the thicknessSENSOR: value, see Fig. 39.

- Fixed output value
- Sensor 1: value
- Sensor 1: intensity
- Sensor 1: shutter speed
- Sensor 1: reflectivity
- Sensor 2: value
- Sensor 2: intensity
- Sensor 2: shutter speed
- Sensor 2: reflectivity
- thicknessSENSOR: value

Fig. 39 Analog output - Output signal drop-down menu

In the Preferences > Analog outputs > Analog output > Output area menu, you can select between analog output, current or voltage, see Fig. 40.

- Inactive
- 0V ... 5V
- 0V ... 10V
- 5V ... 5V
- 10V ... 10V
- 4mA ... 20mA

Fig. 40 Analog output - Output area drop-down menu

In the Preferences > Analog outputs > Analog output > Scaling menu, you can select between Standard scaling and Two-point scaling, see Fig. 41.

Standard scaling

Two-point scaling

Fig. 41 Analog output - Scaling drop-down menu

Analog output 1/2	Output signal ¹	<i>Fixed output value</i>	<i>Output value</i>	<i>Min to Max - value in V resp. mA</i>	Data source can be a sensor signal, the result of the C-Box/2A of the thicknessSENSOR, or a fixed value within the output area.
		<i>Sensor 1/2: Measured value</i>			
		<i>Sensor 1/2: Intensity</i>			
		<i>Sensor 1/2: Shutter speed</i>			
		<i>Sensor 1/2: Reflectivity</i>			
		<i>thicknessSENSOR: Measured value</i>			
	Output area	<i>Inactive / 0V ... 5V / 0V ... 10V / -5V ... 5V / -10V ... 10V / 4mA ... 20mA</i>			Specification of the analog output, current or voltage with selectable value range.
	Scaling	<i>Standard scaling</i>			Standard scaling outputs the entire measuring range of the sensor/ controller.
		<i>Two-point scaling</i>			Two-point scaling requires the indication of the start and end of the range; value range: from -1024 to 1024 mm.
	Two-point scaling (displacement and factor)	Start of range in mm	<i>Value</i>		
		End of range in mm	<i>Value</i>		

1) Only one measuring value can be transferred.

6.4.8 Digital Ports

➡ Go to the Preferences > Digital ports menu.

 Fields with a gray background require a selection.

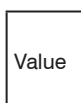
 Dark bordered fields require the specification of a value.



Under Digital input, see Chap. 6.4.8.1, you can configure the function input. Under Digital outputs, see Chap. 6.4.8.2, you can configure the error outputs.

6.4.8.1 Digital Input

The digital input can be used for mastering the thicknessSENSOR measured values.

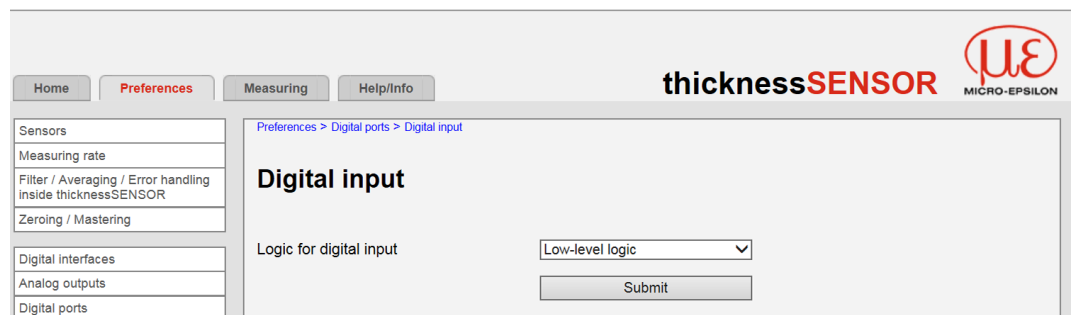

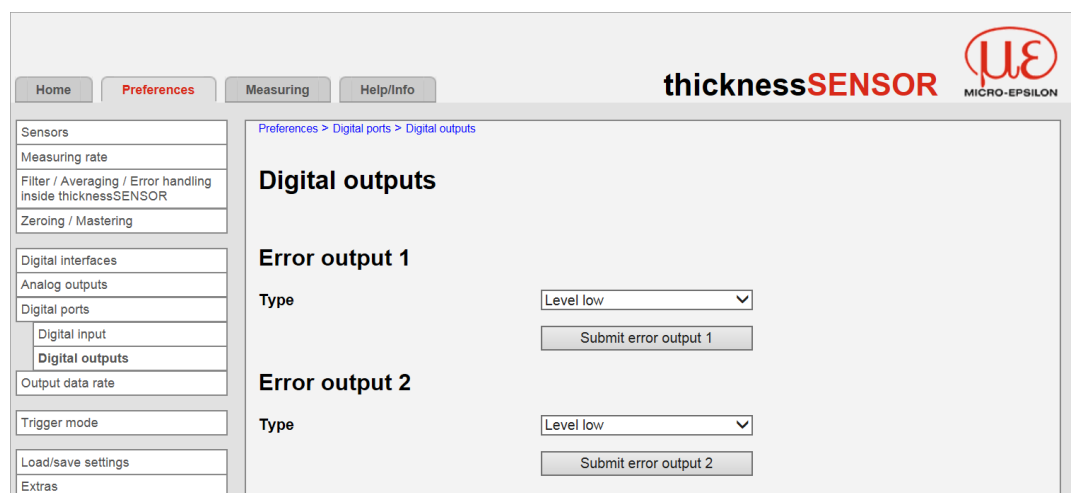

Digital input	Logic for digital input	Low-level logic	Selection of the logic for the digital input	≤0.7 V: Low level
		High-level logic		≥2.2 V: High level
				≤3.0 V: Low level
				≥8.0 V: High level

6.4.8.2 Digital Outputs



➡ Select the function of the error outputs.

 Fields with a gray background require a selection.

 Value
Dark bordered fields require the specification of a value.

Digital out-puts	Error out-put 1/2	Type	<i>Sensor 1/2: Error output 1/2</i>	The value of the selected error output for the selected sensor is output.
			<i>Sensor 1/2: Measured value</i>	Outputs the range check result of measuring value / intensity value / shutter speed value / reflectivity value for the selected sensor.
			<i>Sensor 1/2: Intensity</i>	The allowed range is specified by the upper and lower limit input fields.
			<i>Sensor 1/2: Shutter speed</i>	The allowed range is specified by the upper and lower limit input fields.
			<i>Sensor 1/2: Reflectivity</i>	The allowed range is specified by the upper and lower limit input fields.
			<i>thicknessSENSOR: Measured value</i>	Outputs the range check result for the thicknessSENSOR measuring value. The allowed range is specified by the upper and lower limit input fields.
			<i>Low level</i>	The level is always low at the error output.
			<i>High level</i>	The level is always high at the error output.
			Submit error output 1 / 2	

6.4.9 Output Data Rate

➡ Go to the Preferences > Output data rate menu.

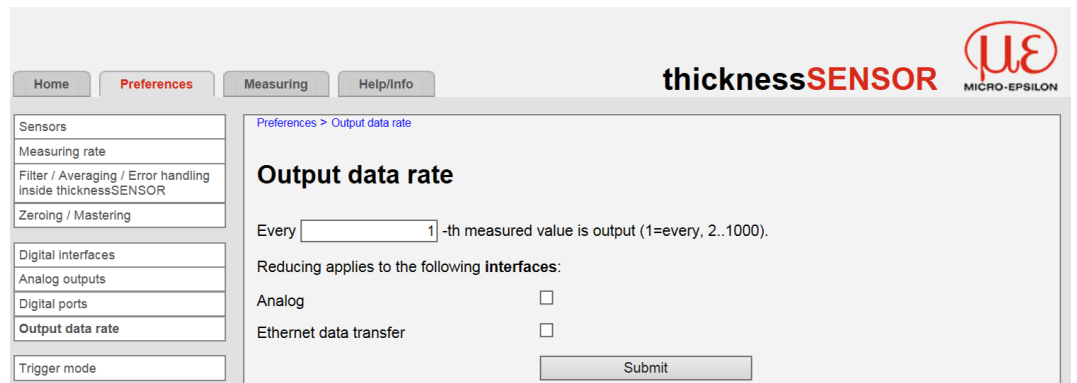

Fig. 42 Preferences - Output data rate screen

The reduction of the output data rate causes only every nth measured value to be output. All other measured values are discarded. Any required averaging for n values must be set separately, see Chap. 6.4.4.

Fields with a gray background require a selection.

Value
Dark bordered fields require the specification of a value.

6.4.10 Trigger Mode

➡ Go to the Preferences > Trigger mode menu.

Trigger mode	Selected mode	<i>No triggering</i>	
		<i>Level triggering</i>	There is a continuous measured value output as long as the selected level is applied. The data output is stopped afterwards. The trigger can be set to high level / low level.
		<i>Edge triggering</i>	The sensor outputs the previously set number of measured values or initiates a continuous measured value output after the trigger event. The trigger can be set to rising edge / falling edge.
		<i>Software triggering</i>	A measured value output is started as soon as a software command is triggered. The trigger moment is defined more inexactly. The sensor outputs the previously set number of measured values or initiates a continuous measured value output after the trigger event.

 Fields with a gray background require a selection.

 Value
Dark bordered fields require the specification of a value.

Selected mode	<i>No triggering</i>				
	<i>Level triggering</i>	Measured value output at	<i>High level</i>	Active logic	<i>High-level logic (HLL)</i>
			<i>Low level</i>		<i>Low-level logic (LLL)</i>
	<i>Edge triggering</i>		<i>Rising edge</i>		<i>High-level logic (HLL)</i>
			<i>Falling edge</i>		<i>Low-level logic (LLL)</i>
<i>Software triggering</i>	Number of measured values	<i>Value</i>			

Active logic

The logic determines the level the trigger switches:

Low-level logic (LLL)

- ≤0.7 V Low level
- ≥2.2 V High level

High-level logic (HLL)

- ≤0.7 V Low level
- ≥8.0 V High level

Number of measured values

- 1...16382: Number of measured values to be output after a trigger event
- 16383: Start of an infinitely measured value output after a trigger event
- 0: Stop of the trigger and ending an infinitely measured value output

i For all measuring tasks, level or edge triggering and external synchronization cannot be combined.

6.4.11 Load/Save Settings

➡ Go to the Preferences > Load/save settings menu.

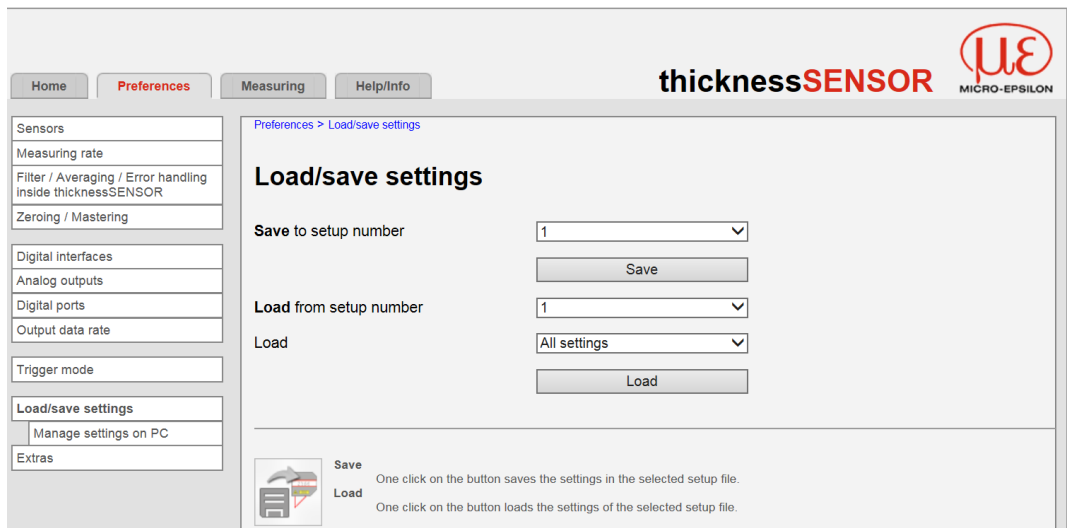

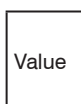

Fig. 43 Preferences - Load/save settings screen

All settings on the controller, e.g. connected sensors and calculation functions, can be permanently saved in user programs, so-called setups, in the controller.

i After the programming, all settings must be permanently stored under a setup no. (1 / 2 / 3 ... 8) in the controller, so that they are available again when the thickness-SENSOR is switched on the next time.

 Fields with a gray background require a selection.

 Value
Dark bordered fields require the specification of a value.

Load/save settings	Save to setup number	1 / 2 / 3 ... 8	Clicking this button saves the settings in the selected setup file.
	Load from setup number	1 / 2 / 3 ... 8	Clicking this button loads the settings from the selected setup file.
	Load	All Settings	All Settings
Interface settings only		Interface settings include the network properties.	
Measuring settings only		Measuring settings only	

6.4.12 Manage Settings on PC

Use this menu to save a backup copy of the settings to a PC or to restore saved settings to the controller.

i Save the controller settings before exporting or importing data, see Chap. 6.4.11.

➔ Go to the Preferences > Load/save settings > Manage settings on PC menu.

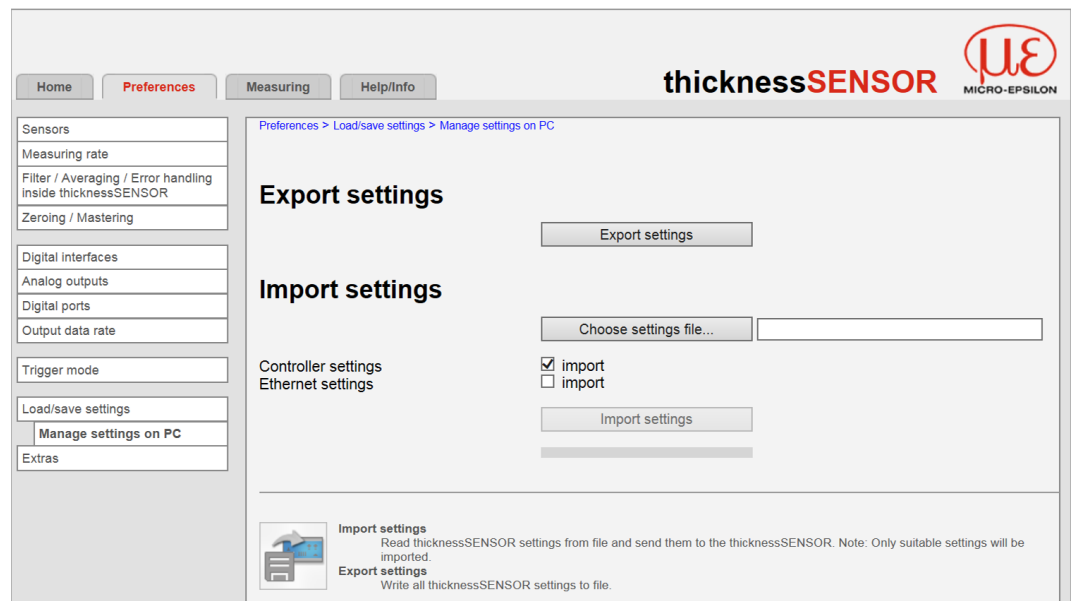



Fig. 44 Preferences - Manage settings on PC screen

 Fields with a gray background require a selection.

 Value
Dark bordered fields require the specification of a value.

Export settings

➡ If you want to save the settings, press the `Export settings` button, see Fig. 44. The `Open thicknessSENSOR_Settings.txt` Windows dialog box opens.

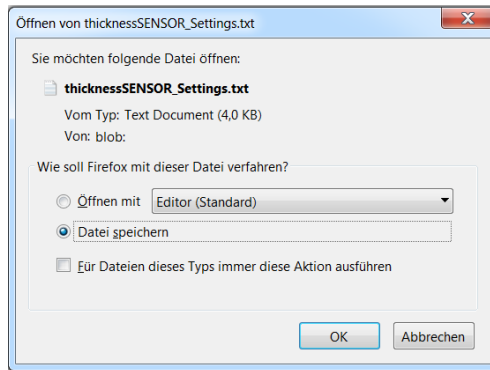

Fig. 45 `Open thicknessSENSOR_Settings.txt` Windows dialog box

➡ Select `Save file`.

The file is saved under your downloads.

➡ Save this download (your setup file) under any path you choose.

All `thicknessSENSOR` settings are now saved in this file and can be loaded at any time again.

Import settings

➡ If you want to load or import the settings, press the `Choose settings file` button under `Import settings`, see Fig. 44.

The `Choose file to upload` Windows dialog box opens.

➡ Select the appropriate parameter set file (*.txt) in the path you selected when exporting and confirm with `Open`.

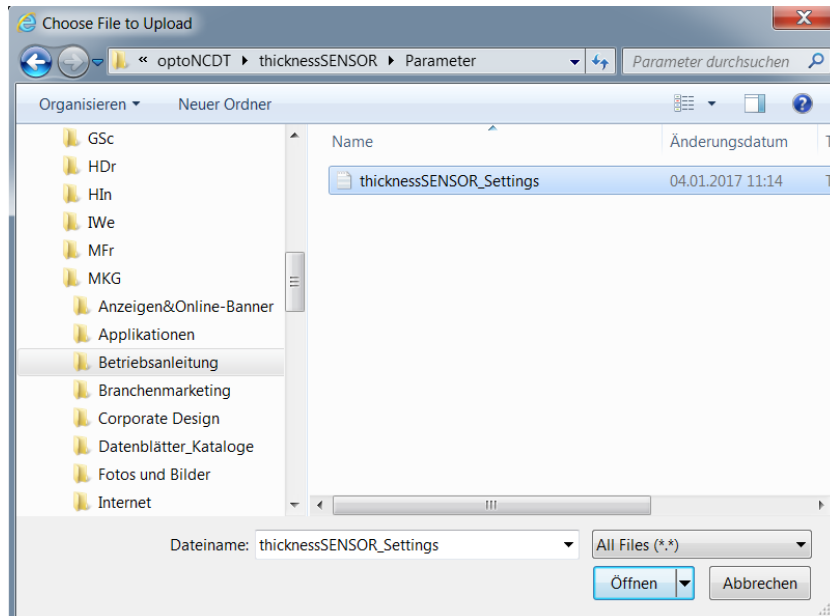

Fig. 46 `Choose file to upload` Windows dialog box

The `thicknessSENSOR` settings are read from the (*.txt) file and sent to the `thicknessSENSOR`.

6.4.13 Extras

6.4.13.1 Language

➡ Go to the Preferences > Extras > Language menu.

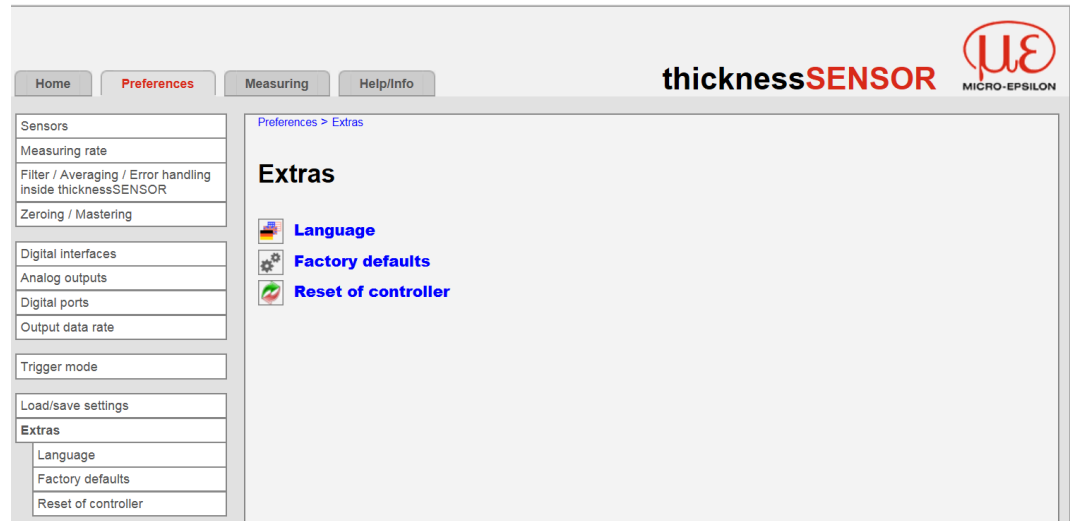

Fig. 47 Preferences - Extras screen

The following menu options are available:

Extras	Language	Language selection	System	Only applies for display in this web interface.
			English	
			German	

The language selection can also be made via the Home > Language selection menu, see Chap. 6.2.3.

6.4.13.2 Factory Defaults

➡ Go to the Preferences > Extras > Factory defaults menu.

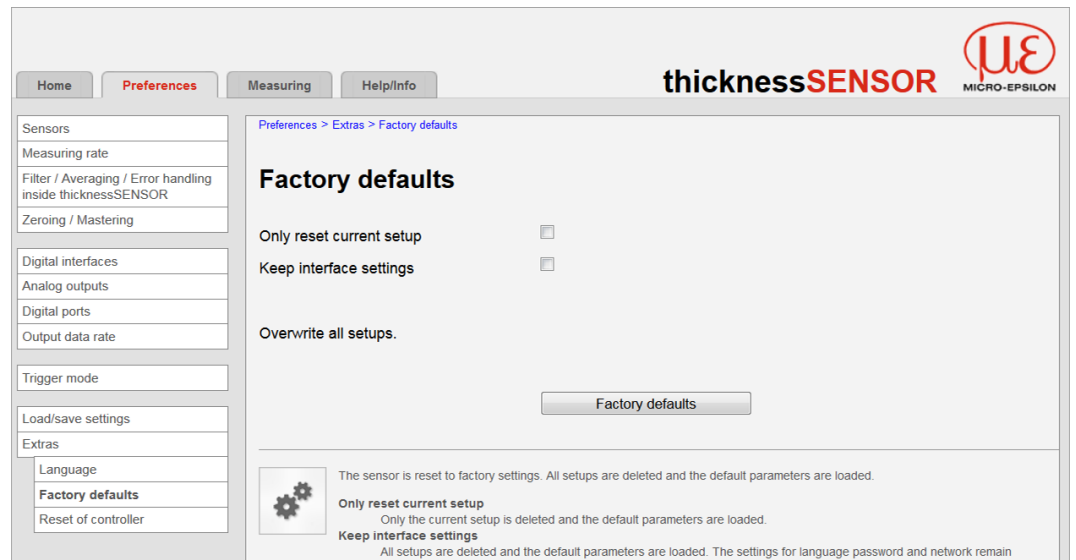

The sensor is reset to the default setting. All setups are deleted and the default parameters are loaded.

 Fields with a gray background require a selection.

 Value
Dark bordered fields require the specification of a value.

➔ Make the following selection for factory defaults:

Intention	Check-box	Meaning
Only reset current setup Keep interface settings	<input checked="" type="checkbox"/>	Only the current setup is deleted and the default parameters are loaded.
	<input type="checkbox"/>	
Only reset current setup Keep interface settings	<input checked="" type="checkbox"/>	Current setup except interface settings is reset.
	<input checked="" type="checkbox"/>	
Only reset current setup Keep interface settings	<input type="checkbox"/>	All setups are deleted and the default parameters are loaded. The settings for language, password and Ethernet remain unchanged.
	<input checked="" type="checkbox"/>	
Overwrite all setups	<input type="checkbox"/>	All setups are deleted and the interface parameters are reset.
	<input type="checkbox"/>	

➔ Confirm the selection by pressing the `Factory defaults` button.

6.4.13.3 Reset of Controller

➔ Go to the `Preferences > Extras > Reset of controller` menu.

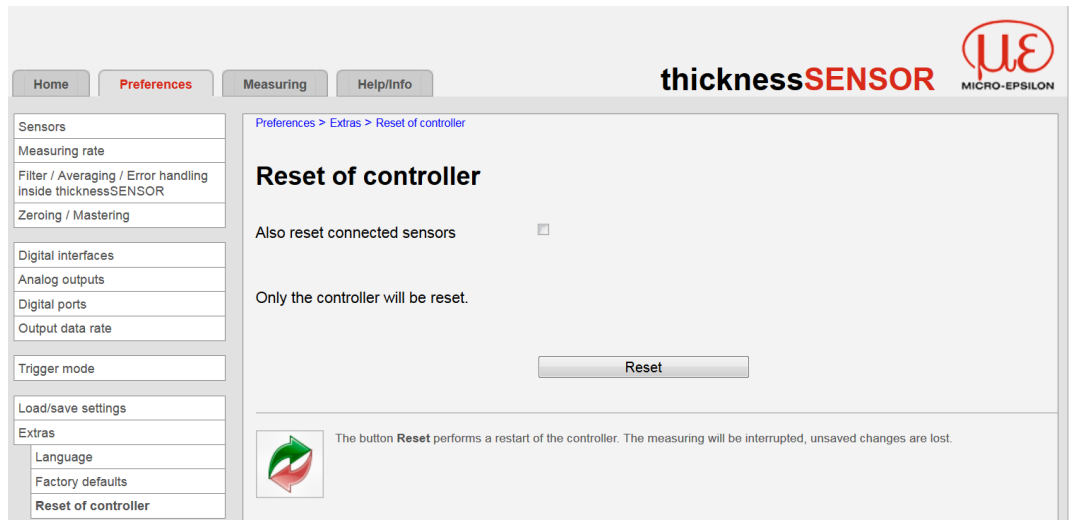

➔ Make the following selection for reset of controller:

Intention	Check-box	Meaning
Also reset connected sensors	<input type="checkbox"/>	Only the controller will be reset.
Also reset connected sensors	<input checked="" type="checkbox"/>	Controller and all connected sensors will be reset.

➔ Confirm the selection by pressing the `Reset` button.

The `Reset` button restarts the controller. The measurement is interrupted, unsaved changes are lost.

6.5 Measuring Menu

➔ Go to the Measuring menu.

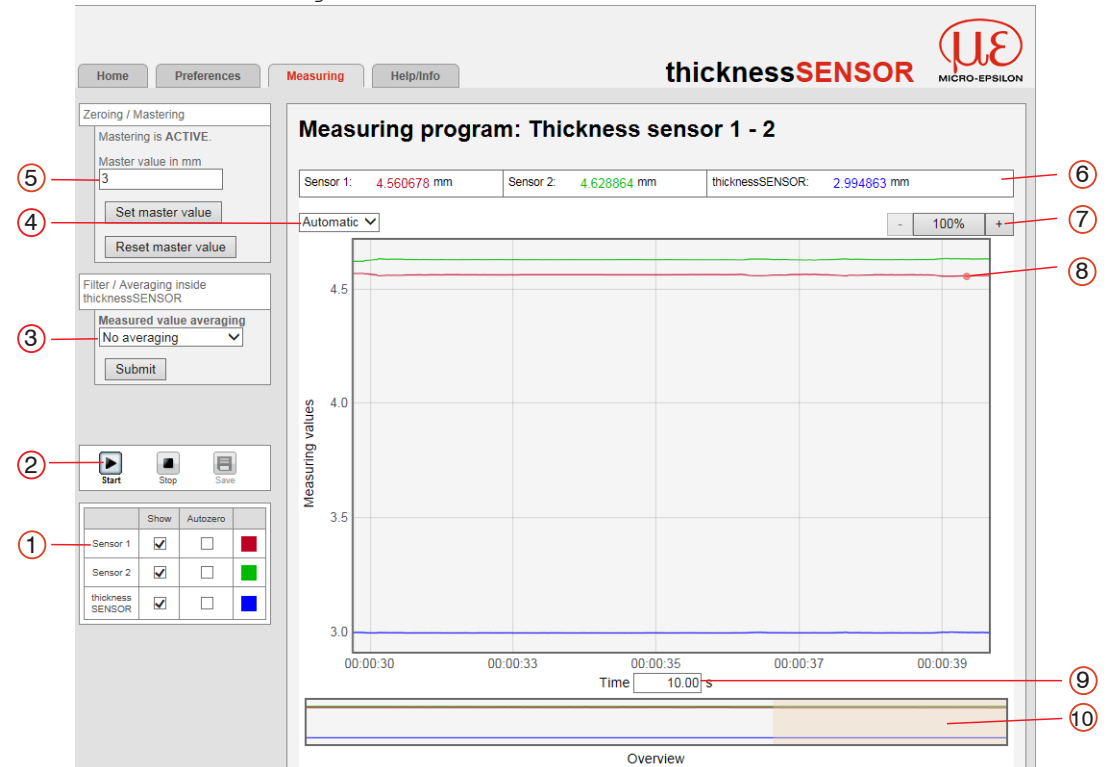

Fig. 48 Measuring menu - Measuring program screen

The left window shows the following functions:

1	Each curve can be deactivated and activated using the associated checkbox (checkmark). The Autozero function starts or stops a relative measurement for the thickness result.				
2	Stop stops the diagram; data selection and zoom function are still possible. Save creates a CSV file (separation with semicolon) to store the last approx. 50000 values. The file contains the accumulated measurement and calculation results including time information. The file is stored in the download area under Windows.				
3	Shows which measured value averaging has been selected, see Chap. 6.4.4. You can also change the measured value averaging here and confirm with Submit. The averaging method is automatically updated in the Filter / Averaging / Error handling inside thicknessSENSOR menu.				
4	For scaling the measured value axis (y-axis) of the graphic, you can either select Auto (= autoscaling) or Manual (= manual setting). <table border="1" style="width: 100%; margin-top: 5px;"> <tr> <td style="width: 50%;">Enable automatic scaling:</td> <td>➔ Select Automatic from the drop-down menu.</td> </tr> <tr> <td>Enable manual scaling:</td> <td>➔ Select Manual from the drop-down menu. The lowest and highest value of the scaling of the y-axis is automatically displayed. The y-axis can be scaled manually.</td> </tr> </table>	Enable automatic scaling:	➔ Select Automatic from the drop-down menu.	Enable manual scaling:	➔ Select Manual from the drop-down menu. The lowest and highest value of the scaling of the y-axis is automatically displayed. The y-axis can be scaled manually.
Enable automatic scaling:	➔ Select Automatic from the drop-down menu.				
Enable manual scaling:	➔ Select Manual from the drop-down menu. The lowest and highest value of the scaling of the y-axis is automatically displayed. The y-axis can be scaled manually.				
5	The master value is used to specify the thickness of a measurement object. Use the Set master value button to set the thickness result to the required value, for example, if you want to make a differential measurement. The function is also used for a calibration measurement, see Chap. 3.3.				
6	The current values of the two laser sensors and the calculated thickness value (thicknessSENSOR value) are displayed in the text boxes above the graphic.				

7	The zoom function scales the time axis during both the measurement and the offline analysis.
8	Mouseover function. When moving the mouse over the graphic in stopped state, curve points are marked with a circle symbol and the related values are displayed in a text box above the graphic.
9	Scaling of the x-axis can be defined by means of an input field below the time axis.
10	Scaling of the x-axis: When the measurement is running, you can use the left slider to enlarge (zoom) the total signal. If the diagram is stopped, you can also use the right slider. The zoom window can also be moved with the mouse in the center of the zoom window (arrow cross).

If the language is set to German, the measured values are stored with a comma as a decimal separator, otherwise with a period.

- Only a limited number of recorded measurements can be stored (about 50000). If more measured values are recorded, the oldest measured values are deleted.

6.6 Help/Info Menu

This page contains information about the serial and version numbers and the MAC address of controller and the attached sensors and an address block.

The screenshot shows the 'thicknessSENSOR' web interface. At the top right is the logo 'thicknessSENSOR MICRO-EPSILON'. Below it are navigation tabs: 'Home', 'Preferences', 'Measuring', and 'Help/Info'. On the left is a contact information box for 'Micro-Epsilon Messtechnik GmbH & Co. KG'. The main content area is titled 'Info controller' and contains a table with the following data:

Name	thicknessSENSOR
Serial number	16070027
Option	000
Article number	8010143
Firmware version	0.0.20
MAC address	00-0C-12-02-06-E5
UUID	8285D72D-530C-4599-945C-1095290F7BD/

Fig. 49 Help/Info menu - Section 1 - Info controller

The screenshot shows the 'Info sensor 1' section with a table containing the following data:

Name	ILD1420
Serial number	16030420
Option	000
Article number	4120212
Firmware version	001.024
MAC address	
Measuring range	10.00mm

Fig. 50 Help/Info menu - Section 2 - Info sensor 1

The screenshot shows the 'Info sensor 2' section with a table containing the following data:

Name	ILD1420
Serial number	16030440
Option	000
Article number	4120212
Firmware version	001.024
MAC address	
Measuring range	10.00mm

Fig. 51 Help/Info menu - Section 3 - Info sensor 2

The screenshot shows the 'Info GUI' section with a table containing the following data:

Build	7771 (Thu Nov 17 15:24:49 2016)
-------	---------------------------------

Fig. 52 Help/Info menu - Section 4 - Info GUI

7. Software Support with MEDAQLib

MEDAQLib offers you a documented driver DLL. Therewith you embed the thickness-SENSOR, in combination with

- Ethernet card
- USB

into an existing or a customized PC software.

MEDAQLib

- contains a DLL, which can be imported into C, C++, VB, Delphi and many more programs,
- performs data conversions,
- works independent of the used interface type,
- is characterized by identical functions for the communication (commands),
- provides a consistent transmission format for all MICRO-EPSILON sensors.

For C/C++ programmers MEDAQLib contains an additional header file and a library file.

You will find the latest driver routine and documentation at:

www.micro-epsilon.de/download

www.micro-epsilon.de/link/software/medaqlib

8. Disclaimer

All components of the device have been checked and tested for functionality in the factory. However, should any defects occur despite careful quality control, these shall be reported immediately to MICRO-EPSILON or to your distributor / retailer.

MICRO-EPSILON undertakes no liability whatsoever for damage, loss or costs caused by or related in any way to the product, in particular consequential damage, e.g., due to

- non-observance of these instructions/this manual,
- improper use or improper handling (in particular due to improper installation, commissioning, operation and maintenance) of the product,
- repairs or modifications by third parties,
- the use of force or other handling by unqualified persons.

This limitation of liability also applies to defects resulting from normal wear and tear (e.g., to wearing parts) and in the event of non-compliance with the specified maintenance intervals (if applicable).

MICRO-EPSILON is exclusively responsible for repairs. It is not permitted to make unauthorized structural and / or technical modifications or alterations to the product. In the interest of further development, MICRO-EPSILON reserves the right to modify the design.

In addition, the General Terms of Business of MICRO-EPSILON shall apply, which can be accessed under Legal details | Micro-Epsilon <https://www.micro-epsilon.com/impresum/>.

9. Service, Repair

If the sensor, controller or sensor cable is defective:

- If possible, save the current sensor settings in a parameter set, see Chap. 6.4.11 to reload them into the sensor/controller after the repair.
- Please send us the affected parts for repair or exchange.

If the cause of a fault cannot be clearly identified, please send the entire measuring system to:

MICRO-EPSILON MESSTECHNIK
GmbH & Co. KG
Königbacher Str. 15
94496 Ortenburg / Germany

Tel. +49 (0) 8542 / 168-0
Fax +49 (0) 8542 / 168-90
info@micro-epsilon.de
www.micro-epsilon.com

10. Decommissioning, Disposal

In order to avoid the release of environmentally harmful substances and to ensure the reuse of valuable raw materials, we draw your attention to the following regulations and obligations:

- Remove all cables from the sensor and/or controller.
- Dispose of the sensor and/or the controller, its components and accessories, as well as the packaging materials in compliance with the applicable country-specific waste treatment and disposal regulations of the region of use.
- You are obliged to comply with all relevant national laws and regulations.

For Germany / the EU, the following (disposal) instructions apply in particular:

- Waste equipment marked with a crossed garbage can must not be disposed of with normal industrial waste (e.g. residual waste can or the yellow recycling bin) and must be disposed of separately. This avoids hazards to the environment due to incorrect disposal and ensures proper recycling of the old appliances. 
- A list of national laws and contacts in the EU member states can be found at https://ec.europa.eu/environment/topics/waste-and-recycling/waste-electrical-and-electronic-equipment-weee_en. Here you can inform yourself about the respective national collection and return points.
- Old devices can also be returned for disposal to MICRO-EPSILON at the address given in the imprint at <https://www.micro-epsilon.de/impressum/>.
- We would like to point out that you are responsible for deleting the measurement-specific and personal data on the old devices to be disposed of.
- Under the registration number WEEE-Reg.-Nr. DE28605721, we are registered at the foundation Elektro-Altgeräte Register, Nordostpark 72, 90411 Nuremberg, as a manufacturer of electrical and/or electronic equipment.

Appendix

A 1 Accessories

PCR3000-x



Multifunction cable;
Length $x = 2, 5, 10$ or 20 m;
drag-chain suitable

Power supply, digital inputs (TTL or HTL)

12-pole M12x1 screw connector and free cable ends

Cable diameter: appr. 7 mm

SCR3000A-x



Ethernet interface cable;

Length $x = 2, 5, 10$ or 20 m;
drag-chain suitable

8-pole M12 screw connector and 8-pole Ethernet cable connector RJ45

Cable diameter: appr. 7 mm

PS2020



Power supply for DIN rail mounting,
input 230 VAC,
output 24 VDC/2.5 A

A 2 Factory Defaults

A 2.1 Home

Language selection: System

A 2.2 Sensors

Sensor 1

Available peaks: Highest peak

Available measurement tasks: Standard

Laser is on

Sensor 2

Available peaks: Highest peak

Available measurement tasks: Standard

Laser is on

A 2.3 Measuring Rate

Measuring rate: 2.0 kHz

A 2.4 Filter / Averaging / Error Handling inside thicknessSENSOR

Measured value averaging: No averaging

Error handling in the case of no valid measured value: Error output, no measurement

A 2.5 Zeroing/Mastering

Mastering is inactive. (No master value set.)

A 2.6 Digital interfaces

Selection of digital interfaces

Interface used for data output: Ethernet transmission of measured values

Data selection

thicknessSENSOR: value: selected

Remaining data not selected

Ethernet settings

Address type: Static IP address

IP Address: 169.254.168.150

Subnet mask: 255.255.0.0

Default gateway: 169.254.1.1

Transmission type: SERVER/TCP

Port: 1024

A 2.7 Analog Outputs

Analog output 1

Output signal: thicknessSENSOR: value

Output area: 0 V...10 V

Scaling: Standard scaling

Analog output 2

Output signal: thicknessSENSOR: value

Output area: 0 V...10 V

Scaling: Standard scaling

A 2.8 Digital Ports

Digital input

Logic for digital input: Low-level logic

Digital outputs

Error output 1 Type: Low level

Error output 2 Type: Low level

A 2.9 Output Data Rate

Every 1-th measured value is output

Reducing applies to the following interfaces:

Analog: not selected

Ethernet data transfer: not selected

A 2.10 Trigger Mode

Selected mode: No triggering

A 2.11 Load/Save Settings

Save to setup number: 1

Load from setup number: 1

Load: All Settings

A 2.12 Extras

Language

Language selection: System

Factory defaults

Only reset current setup: not selected

Keep interface settings: not selected

Reset of controller

Also reset connected sensors: not selected

A 3 Pin Assignment

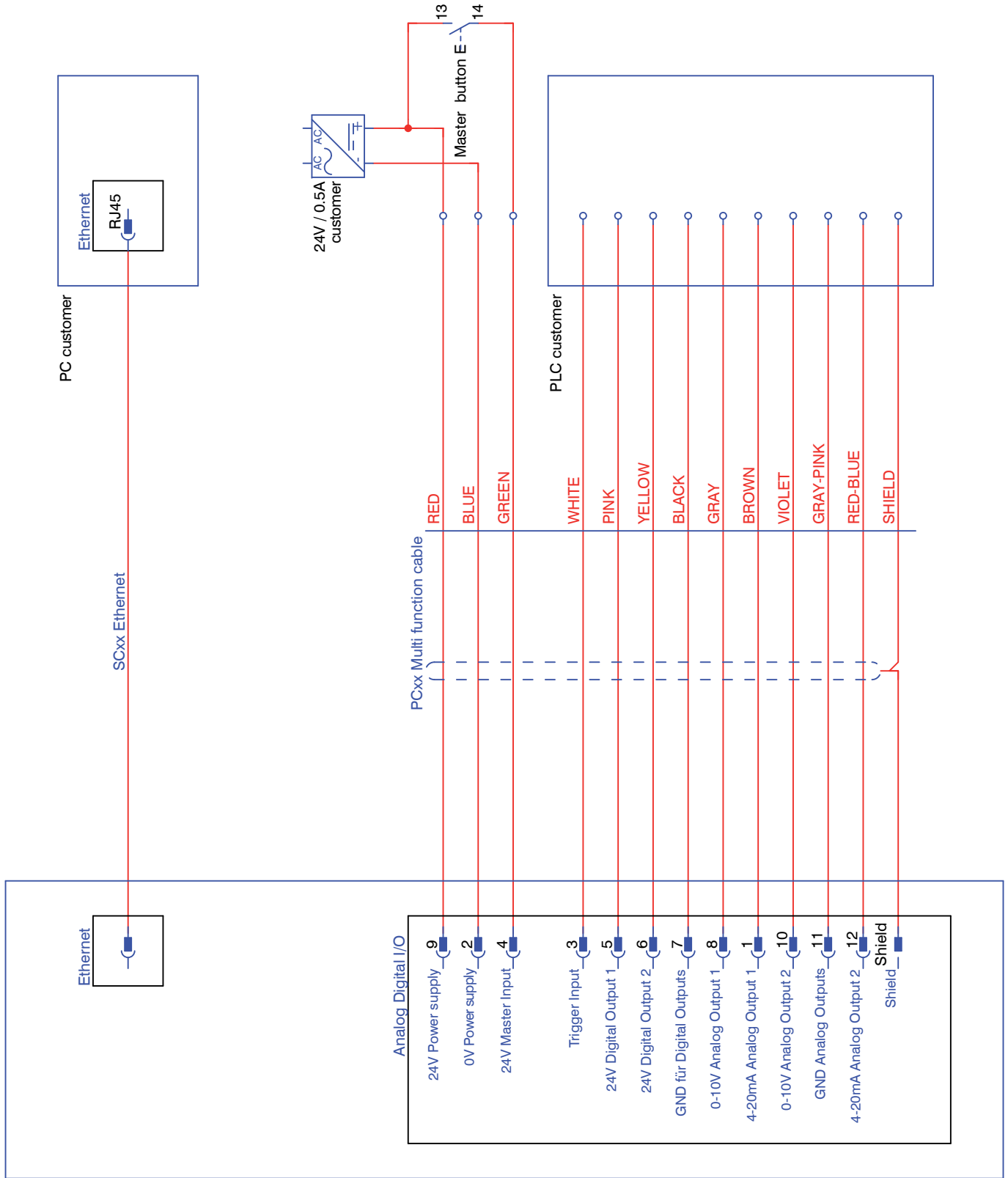

thicknessSENSOR
 4120218
 4120219
 4120220
 4120221

A 4 ASCII Communication with the Sensor

A 4.1 General

The ASCII commands can be sent to the thicknessSENSOR via the USB or Ethernet interfaces. All commands, inputs and error messages are in English. A command always consists of the command name and zero or more parameters, which are separated by spaces and are terminated with CR LF (corresponds to \r\n).

The echo is always active, i.e.:

- In the case of a command for setting parameters, first the command name, then OK or error and finally the prompt is returned as a response.
- In the case of a command for reading parameters, first the command name, then the parameter value and finally the prompt is returned as a response.
- In the case of a command with a multi-line response, first the command name and in the next lines the parameters are returned as a response.

A 4.2 Data Protocol

All values to be output at the same time are grouped together for transmission to a frame. A maximum of 12 values/frame are possible. The measured values are transmitted via TCP/IP with 32 bits and USB with a maximum of 18 data bits.

Structure of a measured value frame:

- Sensor 1 Value
- Sensor 1 Intensity
- Sensor 1 Shutter
- Sensor 1 Reflectivity
- Sensor 2 Value
- Sensor 2 Intensity
- Sensor 2 Shutter
- Sensor 2 Reflectivity
- C-Box Value
- C-Box Counter
- C-Box Timestamp
- C-Box Digital

With the Ethernet transmission a header and then a sequence of data frames is transmitted with each package.

The header consists of:

- Preamble (32 bits): MEAS
- Order number (32 bits)
- Serial number (32 bits)
- Flags1 (32 bits), see [Fig. 53](#)
- Flags2 (32 bits), see [Fig. 54](#), currently no function
- Bytes per frame (16 bits) / Number of frames in the package (16 bits)
- Frame counter (32 bits)

The data frames in the package are always complete (No frame can be distributed on several packages). Each frame consists of his selected measured values (up to 12). Each measured value has again 32 bits.

The valid value ranges for the thicknessSENSOR are as follows:

- Via USB:
 - Sensor measured values and additional values depending on sensor, see also instruction manual of optoNCDT 1420, Chapter 7.5.1.
 - C-Box measured values from 0 .. 131071, from 262073 ... 262143 (18 bits) error values
 - C-Box Counter from 0 .. 262143 (18 bits)
 - C-Box Timestamp from 0 .. 262143 (18 bits)
 - C-Box Digital from 0 .. 262143 (18 bits)
- Via TCP/IP (Ethernet):
 - Sensor measured values and additional values depending on sensor, see also instruction manual of optoNCDT 1420, Chapter 7.5.1.
However, an additional Hi Byte (0x00) is transmitted to comply with 32 bits.
 - C-Box measured values from INT_MIN (-2147483648) to INT_MAX (2147483647)-11, INT_MAX-10 to INT_MAX are error values
 - C-Box Counter from INT_MIN to INT_MAX
 - C-Box Timestamp from INT_MIN to INT_MAX
 - C-Box Digital from INT_MIN to INT_MAX

Flag 1 Bits	Description	Flag 1 Bits	Description
0	Sensor 1 Value	11	Sensor 2 Intensity
1	unused	12	Sensor 2 Shutter
2	Sensor 2 Value	13	Sensor 2 Reflectivity
3	unused	14	C-Box Counter
4	C-Box Value	15	C-Box Timestamp
5 to 7	unused	16	C-Box Digital
8	Sensor 1 Intensity	17 to 30	unused
9	Sensor 1 Shutter	30 to 31	01 (fixed value, to distinguish from C-Box, where it is 00)
10	Sensor 1 Reflectivity		

Fig. 53 Description Flags 1 (Ethernet)

Flag bit	Description
0 to 31	0

Fig. 54 Description Flags 2 (Ethernet)

Value	Port	Value range
Sensor 1 Value, Sensor 2 Value, C-Box Value	USB	0 ... 262072
	Ethernet -INT_MAX ... INT_MAX -11	-2147483647 ... 2147483636
C-Box Counter, C-Box Timestamp, C-Box Digital	USB	0 ... 262143
	Ethernet: -INT_MAX ... INT_MAX	-2147483647 ... 2147483647

Fig. 55 Valid value ranges (raw)

Value	Port	Value range
Sensor 1 Value, Sensor 2 Value, C-Box Value	USB	262073 ... 262143
	Ethernet: INT_MAX -10 ... INT_MAX	2147483637 ... 2147483647

Fig. 56 Error ranges (raw)

Value	Port	Calculation	Unit
C-Box Value	USB		[mm]
		Value = $\frac{\text{Digital} * (\text{C-Box Range Max} - \text{C-Box Range Min})}{131072.0} + \text{C-Box Range Min}$	
	Ethernet	Value = $\frac{\text{Digital}}{1.0e+006}$	[mm]
C-Box Timestamp	USB	Value = $\frac{\text{Digital (Left shift by 8 bits)}}{1.0e+006}$	[s]
	Ethernet	Value = $\frac{\text{Digital (unsigned int)}}{1.0e+006}$	[s]
C-Box-Counter	USB	Digital	without
	Ethernet	Digital (unsigned int)	without
C-Box Digital	see Fig. 58		

Fig. 57 Calculation of the values

thicknessSENSOR Digital		
Bits	Description	
0	Trigger IN (TRG IN)	Pin header input
1	Multi-function input (MF IN)	Pin header input
2	Laser ON (laser)	Pin header input
3	Switching output S1 (OUT S1)	Pin header output
4	Switching output S1 (OUT S2)	Pin header output
5	Multi-function output	Sensor1 output
6	Laser ON	Sensor1 output
7	Switching input 1	Sensor1 input
8	Switching input 2	Sensor1 input
9	Multi-function output	Sensor1 output
10	Laser ON	Sensor2 output
11	Switching input 1	Sensor2 input
12	Switching input 2	Sensor2 input
13 to 15 (or 31)	reserved (0)	

Fig. 58 Description thicknessSENSOR Digital

During a restart or after a configuration change at the thicknessSENSOR, this initializes the sensors and the measuring restarts.

A 4.3 Commands Overview

Group	Chapter	Short description
A 4.4.1	Chap. A 4.4.1	Controller information
A 4.4.2	Chap. A 4.4.2	Search sensor
A 4.4.3	Chap. A 4.4.3	Sensor information
A 4.4.4	Chap. A 4.4.4	Read all settings
A 4.4.5	Chap. A 4.4.5	Language setting
A 4.4.6	Chap. A 4.4.6	Synchronization
A 4.4.7	Chap. A 4.4.7	Boot the controller
A 4.4.8	Chap. A 4.4.8	Triggering
A 4.4.8.1	Chap. A 4.4.8.1	Trigger selection
A 4.4.8.2	Chap. A 4.4.8.2	Trigger level
A 4.4.8.3	Chap. A 4.4.8.3	Number of measured values to be output
A 4.4.8.4	Chap. A 4.4.8.4	Software trigger pulse
A 4.4.9	Chap. A 4.4.9	Ethernet
A 4.4.10	Chap. A 4.4.10	Setting the measured value server
A 4.4.11	Chap. A 4.4.11	Transmission rate
A 4.4.12	Chap. A 4.4.12	Save parameters
A 4.4.13	Chap. A 4.4.13	Load parameters
A 4.4.14	Chap. A 4.4.14	Factory defaults
A 4.4.15	Chap. A 4.4.15	Measurement mode
A 4.4.16	Chap. A 4.4.16	Measuring rate
A 4.4.17	Chap. A 4.4.17	Measured value averaging controller
A 4.4.18	Chap. A 4.4.18	Measured value averaging sensor
A 4.4.19	Chap. A 4.4.19	Mastering / Zeroing
A 4.4.20	Chap. A 4.4.20	Selection digital output
A 4.4.21	Chap. A 4.4.21	Output data rate
A 4.4.22	Chap. A 4.4.22	Scale output values
A 4.4.23	Chap. A 4.4.23	Error handling
A 4.4.24	Chap. A 4.4.24	Data selection for USB
A 4.4.25	Chap. A 4.4.25	Data selection for Ethernet
A 4.4.26	Chap. A 4.4.26	Function selection multi-function input
A 4.4.27	Chap. A 4.4.27	Activate error output, switching output 1
A 4.4.28	Chap. A 4.4.28	Activate error output, switching output 2
A 4.4.29	Chap. A 4.4.29	Limit values
A 4.4.30	Chap. A 4.4.30	Data selection
A 4.4.31	Chap. A 4.4.31	Output area
A 4.4.32	Chap. A 4.4.32	Two-point scaling
A 4.4.33	Chap. A 4.4.33	Send command to connected sensor
A 4.4.34	Chap. A 4.4.34	Laser off / Laser on
A 4.4.35	Chap. A 4.4.35	Find thicknessSENSOR
A 4.5	Chap. A 4.5	Error values via USB
A 4.6	Chap. A 4.6	Error values via Ethernet

A 4.4 Commands

A 4.4.1 Controller Information

```
GETINFO
```

Querying the controller information. Output see example:

```
->GETINFO
Name:          C-Box
Serial:        10000001
Option:        000
Article:       2420072
MAC Address:   00-0C-12-01-06-08
Version:       xxx.xxx.xxx.xx
->
```

A 4.4.2 Search Sensor

```
SCAN1
```

The controller searches for sensors connected to the Sensor 1 socket.

The SCAN2 command causes the controller to search for sensors connected to the Sensor 2 socket.

A 4.4.3 Sensor Information

```
GETINFO1
```

Provides information about the sensor connected to the Sensor 1 socket.

Example of a response if an ILD2300 is connected:

```
->GETINFO1
Name: ILD2300
Serial: 11020009
Option: 001
Article: 2418004
MAC Address: 00-0C-12-01-06-08
Version: 004.093.087.02
Measuring range: 20 mm
...
Imagetype: User
->
```

If the sensor was not recognized by the thicknessSENSOR, the error E39 no sensor found is output.

The GETINFO2 command provides information about the sensor connected to the Sensor 2 socket.

A 4.4.4 Read all Settings

```
PRINT [ALL]
```

Print is used to output all query commands, for each line a response with command names in front.

- ALL: Provides further information

A 4.4.5 Language Setting

```
LANGUAGE BROWSER|ENGLISH|GERMAN
```

Language of the displayed web pages.

- BROWSER means default language

A 4.4.6 Synchronization

```
SYNC NONE|INTERNAL|EXTERNAL [LLL | HLL]
```

- NONE: Sensors are not synchronized, the thicknessSENSOR runs with its own clock and takes just available sensor values.
- INTERNAL: thicknessSENSOR generates sync pulse
- EXTERNAL: External sync pulse is looped through to the sensors
 - With an external triggering, you can switch between Low Level Logic (LLL) and High Level Logic (HLL).
 - Low Level Logic (0 ... 0.7 to 2.8 ... 30)
 - High Level Logic (0 ... 3 to 8 ... 30)

A 4.4.7 Boot the Controller

```
RESET [ALL]
```

The thicknessSENSOR is restarted.

- ALL: Also restart the sensors.

A 4.4.8 Triggering**A 4.4.8.1 Trigger Selection**

```
TRIGGER NONE|EDGE|PULSE|SOFTWARE
```

Selection of the trigger mode

- NONE: No triggering
- EDGE: Flank triggering via TRG-IN (measured value output depends on TRIGGER-COUNT)
- PULSE: Gate triggering via TRG-IN (continuous measured value output as long as TRG-IN is active)
- SOFTWARE: Triggering via the TRIGGERSW command (measured value output depends on TRIGGERCOUNT)

Default = NONE

A 4.4.8.2 Trigger Level

```
TRIGGERLEVEL HIGH|LOW LLL|HLL
```

Sets the active logic level and the switching threshold for the trigger input.

- HIGH|LOW: active logic level
- LLL|HLL: switching threshold
 - LLL = High Level Logic ==> LO = 0..0.7 Volt, HI = 8..30 Volt)
 - HLL = High Level Logic ==> LO = 0..3 Volt, HI = 8..30 Volt)

Default = HIGH LLL

A 4.4.8.3 Number of Measured Values to be Output

```
TRIGGERCOUNT 0|1...16382|INFINITE|16383
```

Determines how many measured values are output after a trigger event.

- 1...16382: Number of measured values to be output after the trigger event
- INFINITE|16383: Start of continuous measured value output after a trigger event
- 0: Stops the continuous measured value output

Default = 1

A 4.4.8.4 Software Trigger Pulse

TRIGGERSW

Generation of a software trigger. If SOFTWARE is not selected in the trigger selection, the error message "E43 triggermode SOFTWARE disabled" is output.

If the command is sent again when the measured value output is active, the triggering is stopped and the measured value output is terminated.

A 4.4.9 Ethernet

IPCONFIG DHCP|STATIC [<IP address> [<Netmask> [<Gateway>]]]

Setting of the Ethernet interface.

- DHCP: IP address and gateway are automatically queried by DHCP. If no DHCP server is available, a link-local address is searched for after approx. 30 seconds.
- STATIC: Sets an IP address, the net mask and the gateway in the format xxx.xxx.xxx.xxx

If the IP address, net mask and/or gateway are not stated, their values remain unchanged.

A 4.4.10 Setting the Measured Value Server

MEASTRANSFER SERVER/TCP [<PORT>]

For measured value output via Ethernet: currently only TCP server is provided.

- The port is freely selectable between 1024 and 65535.

A 4.4.11 Transmission Rate

BAUDRATE <Baud rate>

Setting the interface baud rate to the PC. Possible variants: 115.200 (Default), 8.000.000, 4.000.000, 3.500.000, 3.000.000, 2.500.000, 2.000.000, 1.500.000, 921.600, 691.200, 460.800, 230.400, 9.600 Baud

A 4.4.12 Save Parameters

STORE 1|2|3|4|5|6|7|8

Save the current parameters under the specified number in the Flash. The data set which was saved last will be loaded when the thicknessSENSOR is restarted.

A 4.4.13 Load Parameters

READ ALL|DEVICE|MEAS 1|2|3|4|5|6|7|8

Read the parameters under the specified number from the Flash. The volume of data to be loaded must also be specified:

- ALL: All parameters are loaded.
- DEVICE: Only the basic device settings are loaded (interface parameters).
- MEAS: Only the measurement settings are loaded (all properties for the measurement).

A 4.4.14 Factory defaults

SETDEFAULT [ALL] [NODEVICE]

Sets the default values (reset to factory setting).

- ALL: All setups are deleted and the default parameters are loaded, otherwise only the current setup is deleted.
- NODEVICE: The IP address settings are temporarily retained.

A 4.4.15 Measurement Mode

```
MEASMODE SENSOR1VALUE|SENSOR12THICK|SENSOR12STEP
```

Set measurement mode, possible are:

- SENSOR1VALUE: Measured value of sensor 1
- SENSOR12THICK: The measured values of sensor 1 and sensor 2 are subtracted from the measuring range and both results are added together. If the mastering is active, both values are subtracted from the internal mastering offset.
- SENSOR12STEP: Difference from measured value from sensor 1 minus measured value from sensor 2.

A 4.4.16 Measuring Rate

```
MEASRATE x.xxx
```

Measurement frequency in kHz with three decimal places.

Only measuring rates that support the sensors are permitted. If the synchronization is deactivated, values between 0.400 and 80.000 are permitted.

A 4.4.17 Measured Value Averaging Controller

```
AVERAGE NONE|MOVING|RECURSIVE|MEDIAN [<Averaging depth>]
```

Output averaging of the thicknessSENSOR. The average acts on the thicknessSENSOR measured value at all interfaces, also analog.

- MOVING: Moving average (averaging depth of 2, 4, 8, 16, 32, 64, 128, 256 and 512 possible).
- RECURSIVE: Recursive average (averaging depth of 2, 4, 8, ..., 32768 possible)
- MEDIAN: Median (averaging depth of 3, 5, 7 and 9 possible)

A 4.4.18 Measured Value Averaging Sensor

```
AVERAGE1 NONE|MOVING|RECURSIVE|MEDIAN [<Averaging depth>]
```

Averaging in the sensors. The average always acts on all distance and difference values to be output.

- MOVING: Moving average ¹
- RECURSIVE: Recursive average ¹
- MEDIAN: Median ¹

The AVERAGE2 NONE|MOVING|RECURSIVE|MEDIAN [<Averaging depth>] command sets the average of the sensor connected to the Sensor 2 socket.

A 4.4.19 Mastering / Zeroing

```
MASTERMV NONE|MASTER <Master value>
```

Mastering of the thicknessSENSOR.

- NONE: Terminates the mastering
- MASTER: Setting the current measured value as master value
 - Master value in millimeters (min: -1024.0 mm, max: 1024.0 mm)
 - If the master value is 0, the mastering function has the same function as the zero setting.

A 4.4.20 Selection Digital Output

```
OUTPUT NONE|ETHERNET|HTTP|USB
```

Activates the data output at the desired interface.

- NONE: No measured value output
- ETHERNET: Output of measured values via Ethernet
- HTTP: Output of measured values via the thicknessSENSOR web page
- USB: Output of measured values via USB

1) Only those values which are also supported by the sensor are possible.

A 4.4.21 Output Data Rate

```
OUTREDUCE <Output reduction> ([ANALOG] [USB] [ETHERNET])|NONE
```

Reduces the measured value output for all available interfaces.

- 1: Output of every measured value
- 2 ... 1000: Output of each n-th measured value

A 4.4.22 Scale Output Values

```
OUTSCALE_RS422_USB STANDARD|(TWOPOINT <Minimum measured value> <Maximum measured value>)
```

Sets the scaling of the C-BOXVALUE via USB.

The default scaling is for distance/level 0 to MR (Sensor1) and for thickness measurement 0 to MR (Sensor1) + MR (Sensor2) (MR = measuring range).

The minimum and maximum measured value must be indicated in millimeters. The available output area of the USB output is then spread between the minimum and maximum measured value. The minimum and maximum measured value must be between -1024.0 and 1024.0 mm with four decimal places. The max value must be greater than the min value.

A 4.4.23 Error Handling

```
OUTHOLD NONE|0|<Number>
```

Setting the behavior of the measured value output in case of error for the thicknessSENSOR measured value, not for the sensor values.

- NONE: No holding the last measured value, output of error value.
- 0: Infinite holding of the last measured value.
- Number: Holding the last measured value over a number of measuring cycles; then an error value (maximum 1024) is output.

A 4.4.24 Data Selection for USB

```
OUT_USB NONE|([SENSOR1VALUE] [SENSOR1INTENSITY] [SENSOR1SHUTTER] [SENSOR1REFLECTIVITY] [SENSOR2VALUE] [SENSOR2INTENSITY] [SENSOR2SHUTTER] [SENSOR2REFLECTIVITY] [C-BOXVALUE] [C-BOXCOUNTER] [C-BOXTIMESTAMP] [C-BOXDIGITAL])
```

Setting which values are to be output via USB.

- NONE: No output of a distance
- SENSOR1VALUE: Measured value of Sensor 1
- SENSOR1INTENSITY: Intensity of Sensor 1
- SENSOR1SHUTTER: Shutter speed of Sensor 1
- SENSOR1REFLECTIVITY: Reflectivity of Sensor 1
- SENSOR2INTENSITY: Intensity of Sensor 2
- SENSOR2VALUE: Measured value of Sensor 2
- SENSOR2SHUTTER: Shutter speed of Sensor 2
- SENSOR2REFLECTIVITY: Reflectivity of Sensor 2
- C-BOXVALUE: Calculated value of thicknessSENSOR
- C-BOXCOUNTER: Counter value of thicknessSENSOR
- C-BOXTIMESTAMP: Timestamp of thicknessSENSOR
- C-BOXDIGITAL: Digital inputs/outputs of thicknessSENSOR

A 4.4.25 Data Selection for Ethernet

```
OUT_ETH NONE | ([SENSOR1VALUE] [SENSOR1INTENSITY] [SENSOR1SHUTTER] [SENSOR-
1REFLECTIVITY] [SENSOR2VALUE] [SENSOR2INTENSITY] [SENSOR2SHUTTER] [SENSOR-
2REFLECTIVITY] [C-BOXVALUE] [C-BOXCOUNTER] [C-BOXTIMESTAMP] [C-BOXDIGITAL])
```

Setting which values are to be output via Ethernet.

- NONE: No output of a distance
- SENSOR1VALUE: Measured value of Sensor 1
- SENSOR1INTENSITY: Intensity of Sensor 1
- SENSOR1SHUTTER: Shutter speed of Sensor 1
- SENSOR1REFLECTIVITY: Reflectivity of Sensor 1
- SENSOR2VALUE: Measured value of Sensor 2
- SENSOR2INTENSITY: Intensity of Sensor 2
- SENSOR2SHUTTER: Shutter speed of Sensor 2
- SENSOR2REFLECTIVITY: Reflectivity of Sensor 2
- C-BOXVALUE: Calculated value of thicknessSENSOR
- C-BOXCOUNTER: Counter value of thicknessSENSOR
- C-BOXTIMESTAMP: Timestamp of thicknessSENSOR
- C-BOXDIGITAL: Digital inputs/outputs of thicknessSENSOR

A 4.4.26 Function Selection Multi-function Input

```
MFIFUNC NONE | MASTER | SENSOR1 | SENSOR2 | SENSOR12 LLL | HLL
```

Function of the multi-function input, either mastering or output to one or both multi-function outputs (sensor).

- NONE -> No function
- MASTER -> C-Box mastering
- SENSOR1 -> Multi-function output for sensor 1
- SENSOR2 -> Multi-function output for sensor 2
- SENSOR12 -> Multi-function output for sensor 1 and 2
- LLL -> Low Level Logic input
- HLL -> High Level Logic input

A 4.4.27 Activate Error Output, Switching Output 1

```
ERROROUT1 SENSOR1ERROROUT1 | SENSOR1ERROROUT2 | SENSOR2ERROROUT1 | SENSOR-
2ERROROUT2 | SENSOR1VALUE | SENSOR1INTENSITY | SENSOR1SHUTTER | SENSOR1RE-
FLECTIVITY | SENSOR2VALUE | SENSOR2INTENSITY | SENSOR2SHUTTER | SENSOR2REFLEC-
TIVITY | C-BOXVALUE | LOW | HIGH
```

Select the signal source for the switching output 1 (to the periphery).

The first four switch only one error output of the sensors.

The next nine monitor values from the thicknessSENSOR.

The last two switch the output to a level by command.

A 4.4.28 Activate Error Output, Switching Output 2

```
ERROROUT2 SENSOR1ERROROUT1 | SENSOR1ERROROUT2 | SENSOR2ERROROUT1 | SENSOR-
2ERROROUT2 | SENSOR1VALUE | SENSOR1INTENSITY | SENSOR1SHUTTER | SENSOR1RE-
FLECTIVITY | SENSOR2VALUE | SENSOR2INTENSITY | SENSOR2SHUTTER | SENSOR2REFLEC-
TIVITY | C-BOXVALUE | LOW | HIGH
```

Select the signal source for the switching output 2 (to the periphery).

The first four switch only one error output of the sensors.

The next nine monitor values from the sensors or the thicknessSENSOR.

The last two switch the output to a level by command.

A 4.4.29 Limit Values

```
ERRORLIMIT1 <Lower limit value><Upper limit value>
```

If a measured value or calculated value is to be monitored using ERROROUT1, the limits can be set here.

The minimum and maximum measured value is processed with four decimal places.

```
ERRORLIMIT2 <Lower limit value><Upper limit value>
```

If a measured value or calculated value is to be monitored using ERROROUT2, the limits can be set here.

The minimum and maximum measured value is processed with four decimal places.

A 4.4.30 Data Selection

```
ANALOGOUT1 SENSOR1VALUE|SENSOR1INTENSITY|SENSOR1SHUTTER|SENSOR1REFLECTIVITY|SENSOR2VALUE|SENSOR2INTENSITY|SENSOR2SHUTTER|SENSOR2REFLECTIVITY|C-BOXVALUE|FIXED [Value]
```

Selection of the signal to be output via the analog output1.

For FIXED, the voltage/current value is indicated with four decimal places.

```
ANALOGOUT2 SENSOR1VALUE|SENSOR1INTENSITY|SENSOR1SHUTTER|SENSOR1REFLECTIVITY|SENSOR2VALUE|SENSOR2INTENSITY|SENSOR2SHUTTER|SENSOR2REFLECTIVITY|C-BOXVALUE|FIXED [Value]
```

Selection of the signal to be output via the analog output2.

For FIXED, the voltage/current value is indicated with four decimal places.

A 4.4.31 Output Area

```
ANALOGRANGE1 NONE|0-5V|0-10V|-5-5V|-10-10V|4-20mA
```

- NONE: No analog output (inactive)
- 0 - 5 V: The analog output1 outputs a voltage of 0 to 5 volts.
- 0 - 10 V: The analog output1 outputs a voltage of 0 to 10 volts.
- -5 - 5 V: The analog output1 outputs a voltage of -5 to 5 volts.
- -10 - 10 V: The analog output1 outputs a voltage of -10 to 10 volts.
- 4 - 20 mA: The analog output1 outputs a current of 4 to 20 mA.

```
ANALOGRANGE2 NONE|0-5V|0-10V|-5-5V|-10-10V|4-20mA
```

- NONE: No analog output (inactive)
- 0 - 5 V: The analog output2 outputs a voltage of 0 to 5 volts.
- 0 - 10 V: The analog output2 outputs a voltage of 0 to 10 volts.
- -5 - 5 V: The analog output2 outputs a voltage of -5 to 5 volts.
- -10 - 10 V: The analog output2 outputs a voltage of -10 to 10 volts.
- 4 - 20 mA: The analog output2 outputs a current of 4 to 20 mA.

A 4.4.32 Two-point Scaling

```
ANALOGSCALE1 STANDARD|(TWOPOINT <Minimum measured value> <Maximum measured value>)
```

Setting the scaling of analog output1.

The standard scaling is for distances $-MR/2$ to $MR/2$, for thickness measurement 0 to 2 MR (MR = measuring range), for intensity 0 to 100 %.

If the minimum and maximum measured value is '0', standard scaling is used.

The minimum and maximum measured value must be indicated in millimeters (distance/thickness) or % (intensity).

The available output area of the analog output is then spread between the minimum and maximum values. The minimum and maximum measured value must be between -1024.0 and 1024.0 mm with four decimal places.

The minimum and maximum measured value is processed with four decimal places.

```
ANALOGSCALE2 STANDARD|(TWOPOINT <Minimum measured value> <Maximum measured value>)
```

Setting the scaling of analog output2.

The standard scaling is for distances $-MR/2$ to $MR/2$, for thickness measurement 0 to 2 MR (MR = measuring range), for intensity 0 to 100 %.

If the minimum and maximum measured value is '0', standard scaling is used.

The minimum and maximum measured value must be indicated in millimeters (distance/thickness) or % (intensity).

The available output area of the analog output is then spread between the minimum and maximum values. The minimum and maximum measured value must be between -1024.0 and 1024.0 mm with four decimal places.

The minimum and maximum measured value is processed with four decimal places.

A 4.4.33 Send Command to Connected Sensor

```
TUNNEL1 <Command for Sensor 1>
```

The command is enclosed in quotation marks and is sent by the thicknessSENSOR with a <CRLF> to the sensor connected to the Sensor 1 socket. The response of the sensor is packaged and returned in quotation marks.

If no prompt is received, then the response is waited for up to 15000 ms and then an error is returned.

If no sensor has been detected in the thicknessSENSOR, an error message is returned immediately.

Example of a tunnel communication, the echo in the sensor is switched off:

```
Command: TUNNEL1 „LASERPOW“<CRLF>
```

```
Response: TUNNEL1 „LASERPOW FULL“<CRLF>->
```

```
Command: TUNNEL1 „LASERPOW FULL“<CRLF>
```

```
Response: TUNNEL1 „<CRLF>“<CRLF>->
```

```
Command: TUNNEL1 „GETINFO“<CRLF>
```

```
Response: TUNNEL1 „<CRLF><CRLF>Name:ILD2300<CRLF>Serial:1020004<CRLF>...“<CRLF>->
```

The TUNNEL2 command sends commands to the sensor connected to the Sensor 2 socket.

A 4.4.34 Laser off / Laser on

```
LASERPOW1 OFF|ON
```

Line for laser on/off. When the laser is enabled by a jumper between Laser ON and GND, it can be switched via the LASERPOW1 OFF/ON command.

The LASERPOW2 command works in the same way and is addressed to the sensor connected to the Sensor 2 socket.

A 4.4.35 Find thicknessSENSOR

Search the thicknessSENSOR by using the sensorTOOL, see chapter 6.2.2.

A 4.5 Error Values via USB

262073	USB scaling underflow
262074	USB scaling overflow
262075	Too much data for this baud rate
262079	Measure value cannot be calculated
262080	Measure value cannot be examined, global error

A 4.6 Error Values via Ethernet

7fffff8	Measure value cannot be calculated
7fffff7	Measure value cannot be examined, global error



MICRO-EPSILON MESSTECHNIK GmbH & Co. KG
Königbacher Str. 15 · 94496 Ortenburg / Germany
Tel. +49 (0) 8542 / 168-0 · Fax +49 (0) 8542 / 168-90
info@micro-epsilon.de · www.micro-epsilon.com
Your local contact: www.micro-epsilon.com/contact/worldwide/

X9751370-A042053MSC
© MICRO-EPSILON MESSTECHNIK